

Light for your home
Since 1994

Nowodvorski
L I G H T I N G

CAMELEON SYSTEM

UNLIMITED POSSIBILITIES
NIEOGRANICZONE MOŻLIWOŚCI
НЕОГРАНИЧЕННЫЕ ВОЗМОЖНОСТИ

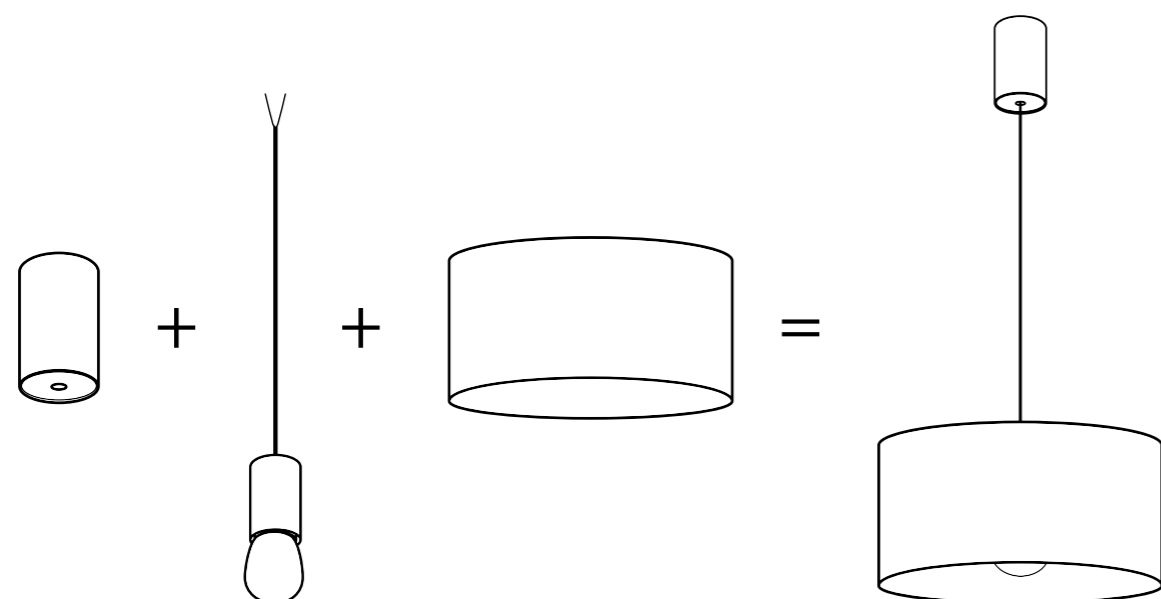

CREATE YOUR OWN LIGHT SYSTEM USING
OUR ELEMENTS

STWÓRZ SWÓJ SYSTEM ŚWIETLNY WYBIERAJĄC NASZE ELEMENTY
СОЗДАЙ СВОЙ СВЕТ, ВЫБИРАЯ НАШИ КОМПОНЕНТЫ

HOW IT WORKS?

JAK TO DZIAŁA?
КАК ЭТО РАБОТАЕТ?

CHOOSE

WYBIERZ
ВЫБРАТЬ

BUY

KUP
КУПИТЬ

ASSEMBLE

ZŁÓŻ
СОБИРАТЬ

SCAN QR CODE TO LEARN HOW IT WORKS

ZESKANUJ KOD QR ABY DOWIEDZIEĆ SIĘ WIĘCEJ
СКАНИРУЙТЕ QR-КОД, ЧТОБЫ УЗНАТЬ, КАК ОНО РАБОТАЕТ



COMPLETE LAMP

KOMPLETNA LAMPA
ЗАВЕРШЕННЫЙ СВЕТИЛЬНИК

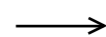
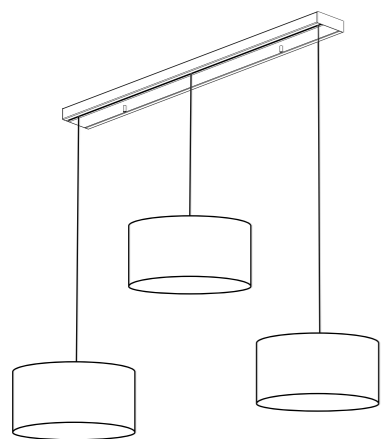

CAMELEON LAMP SHADES

CAMELEON KLOSZE
CAMELEON ПЛАФОНЫ

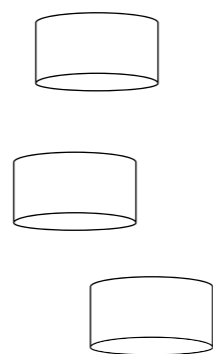

CAMELEON SUSPENSION

CAMELEON ZAWIESZENIE
CAMELEON ПОДВЕС

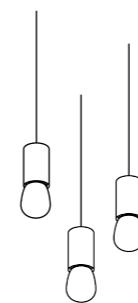

CAMELEON FIXING

CAMELEON AKCESORIA MONTAŻOWE
CAMELEON АКЦЕССУАРЫ ДЛЯ КРЕПЛЕНИЯ

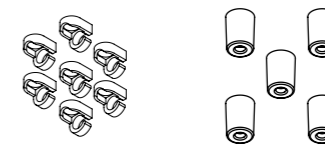
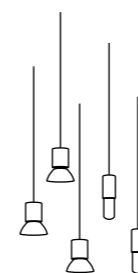
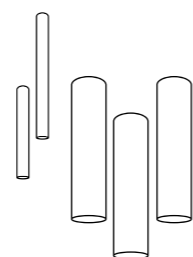
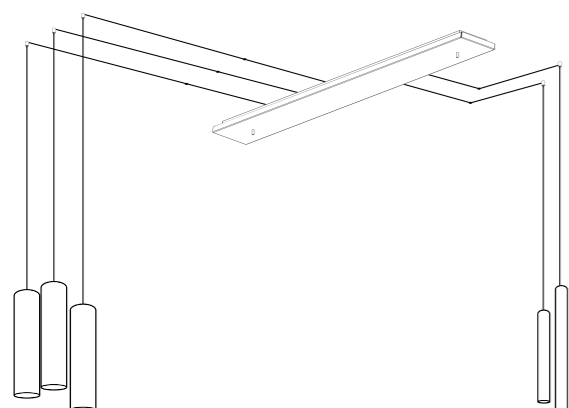
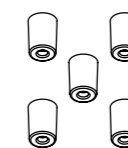
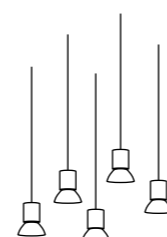
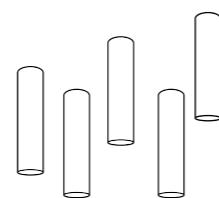
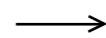
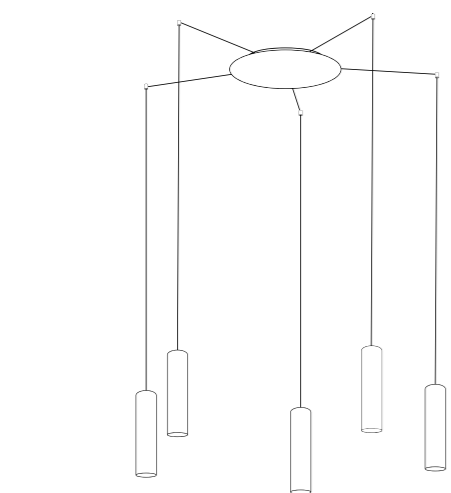
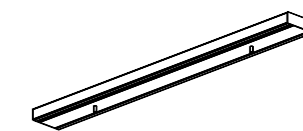

CHOOSE

CHOOSE ELEMENTS TO CREATE PERFECTLY FUNCTIONAL LAMP FOR YOUR HOME

WYBIERZ

WYBIERZ ELEMENTY DO ZŁOŻENIA LAMPY IDEALNIE DOPASOWANEJ DO TWOJEGO DOMU

ВЫБРАТЬ

ВЫБЕРИТЕ ЭЛЕМЕНТЫ ДЛЯ СБОРКИ СВЕТИЛЬНИКА, ИДЕАЛЬНО ПОДОБРОННОГО К ВАШЕМУ ДОМУ

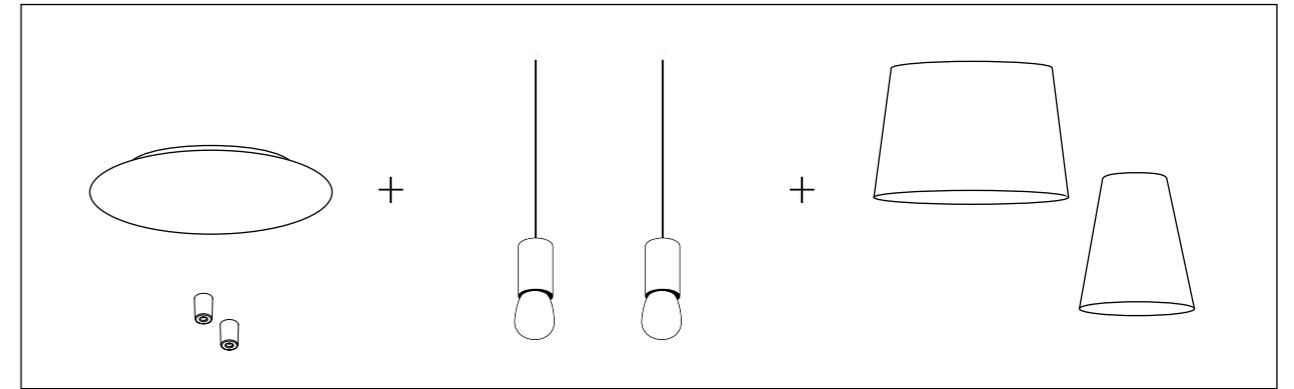

1. CHOOSE ELEMENTS TO CREATE PERFECTLY FUNCTIONAL LAMP FOR YOUR HOME

1. WYBIERZ ELEMENTY DO ZŁOŻENIA LAMPY IDEALNIE DOPASOWANEJ DO TWOJEGO DOMU

1. ВЫБЕРИТЕ ЭЛЕМЕНТЫ ДЛЯ СБОРКИ СВЕТИЛЬНИКА, ИДЕАЛЬНО ПОДОБРОННОГО К ВАШЕМУ ДОМУ

BUY

BUY CORRECT AMOUNT OF :

- CAMELEON
- LAMP SHADES
- SUSPENSION
- CANOPY
- FIXING

KUP

ODPOWIEDNIĄ ILOŚĆ ELEMENTÓW:

- CAMELEON
- KLOSZE
- ZAWIESZENIE
- PUSZKA
- AKCESORIA MONTAŻOWE

КУПИТЬ

ПРАВИЛЬНОЕ КОЛИЧЕСТВО ЭЛЕМЕНТОВ:

- CAMELEON
- ПЛАФОНЫ
- ПОДВЕС
- ОСНОВАНИЕ
- АКССУАРЫ ДЛЯ КРЕПЛЕНИЯ

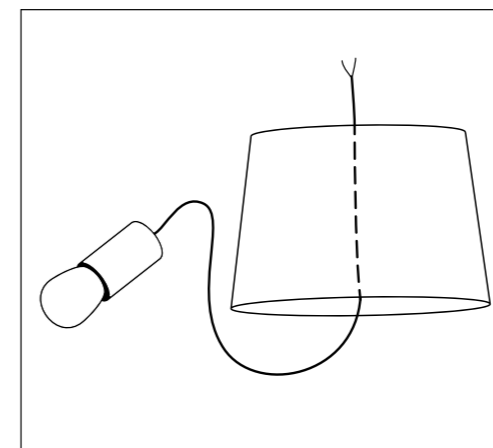

2. PUT THE SUSPENSION THROUGH THE LAMP SHADE

2. PRZEŁÓŻ ZAWIESZENIE PRZEZ KLOSZ

2. ПЕРЕМЕСТИ ПОДВЕС ЧЕРЕЗ ПЛАФОН

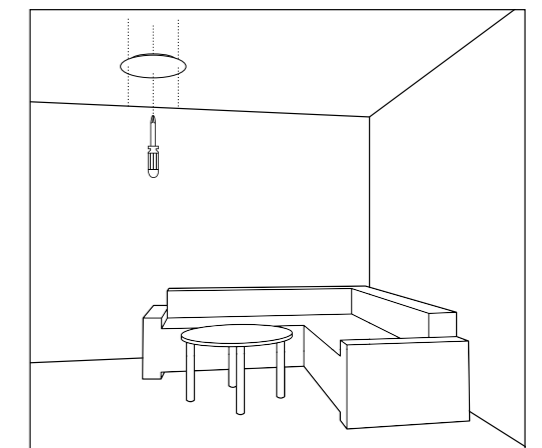

3. FIX THE CAMELEON CANOPY

3. PRZYKRĘĆ PUSZKĘ

3. ПРИВИНТИТЬ ОСНОВАНИЕ

ASSEMBLE

EASY ASSEMBLING ACCORDING TO THE USER'S MANUAL

ZŁÓŻ

ŁATWY MONTAŻ WEDŁUG ZAŁĄCZONEJ INSTRUKCJI

СОБИРАТЬ

ЛЕГКАЯ СБОРКА В СООТВЕТСТВИИ С ПРИЛАГАЕМОЙ ИНСТРУКЦИЕЙ

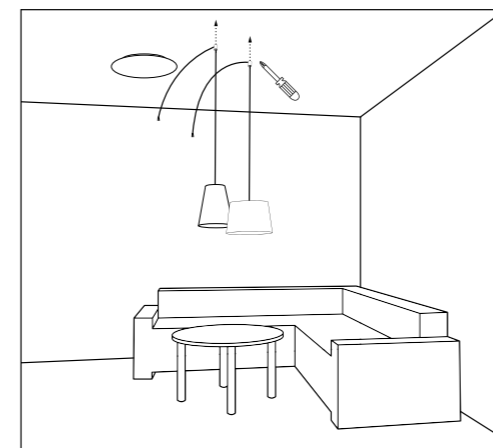

4. FIX THE SUSPENSION

4. ZAMOCUJ ZAWIESZENIE

4. КРЕПИТЬ ПОДВЕС

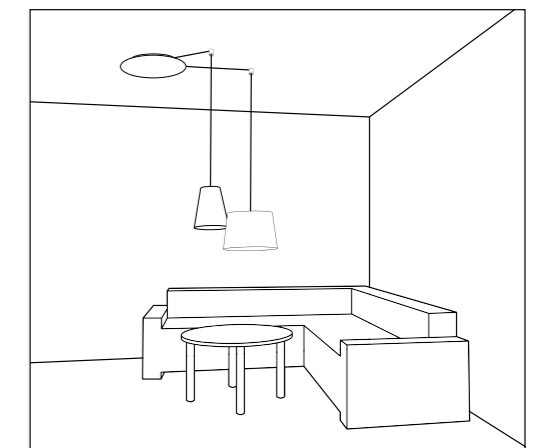

5. CONNECT THE FIXTURES TO THE CAMELEON CANOPY

5. PODŁĄCZ ZAWIESZENIE DO PUSZKI

5. ПОДКЛЮЧИТЬ СВЕТИЛЬНИК К ОСНОВАНИЮ CAMELEON



inspiration



ELEMENTS INCLUDED / UŻYTE ELEMENTY / ИСПОЛЬЗОВАННЫЕ ЭЛЕМЕНТЫ

ELEMENT	ITEM NO.	PAGE
1 CANOPY A	8563	69
2 CABLE GU10	8630	68
3 MOUNTING B	8393	73
4 MOUNTING A	8395	73
5 CYLINDER S	8546	38
6 CYLINDER M	8543	38
7 CYLINDER L	8540	38

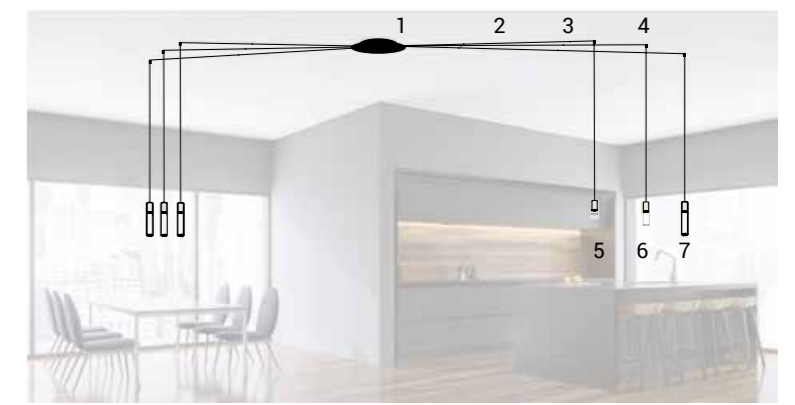



ELEMENTS INCLUDED / UŻYTE ELEMENTY / ИСПОЛЬЗОВАННЫЕ ЭЛЕМЕНТЫ

	ELEMENT	ITEM NO.	PAGE
1	CANOPY A	8566 8565	69
2	CABLE G9	8631	68
3	MOUNTING B	8393	73
4	MOUNTING A	8395	73
5	PICO A	8591	22
6	PICO B	8590	22





ELEMENTS INCLUDED / UŻYTE ELEMENTY / ИСПОЛЬЗОВАННЫЕ ЭЛЕМЕНТЫ

ELEMENT	ITEM NO.	PAGE
1 CANOPY B 780	8561	70
2 CANOPY C 780	8556	71
3 CABLE G9	8632	68
4 CABLE E27	8670	68
5 LASER	8567	28
6 EGG M	8607	26





ELEMENTS FOR ASSEMBLY

ELEMENTY DO MONTAŻU
МОНТАЖНЫЕ ЭЛЕМЕНТЫ



CAMELEON WAVE L
8600 G



CAMELEON WAVE S

painted steel / stal lakierowana / лакированная сталь

8606 ○ WH 8605 ● BL

works with / zastosuj z / применять с

Ⓟ 1× CAMELEON CABLE E27

Ⓟ 1× CAMELEON CABLE GU10

electroplated brass / stal mosiadzowana / латунная сталь

8604 ● G

works with / zastosuj z / применять с

Ⓟ 1× CAMELEON CABLE E27

Ⓟ 1× CAMELEON CABLE GU10

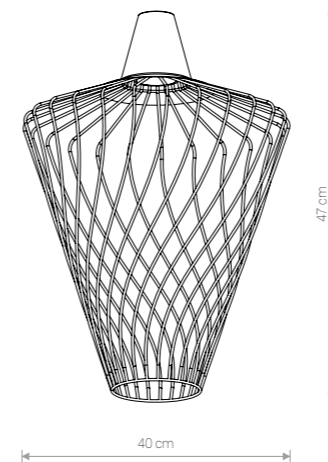

CAMELEON WAVE L

painted steel / stal lakierowana / лакированная сталь

8603 ○ WH 8602 ● BL

works with / zastosuj z / применять с

Ⓟ 1× CAMELEON CABLE E27

Ⓟ 1× CAMELEON CABLE GU10

electroplated brass / stal mosiadzowana / латунная сталь

8600 ● G

works with / zastosuj z / применять с

Ⓟ 1× CAMELEON CABLE E27

Ⓟ 1× CAMELEON CABLE GU10

CAMELEON WAVE S
8606 WH



CAMELEON WAVE S
8604 G



CAMELEON WAVE L
8602 BL





CAMELEON LUKSOR L
8592 G

CAMELEON LUKSOR S
8596 G

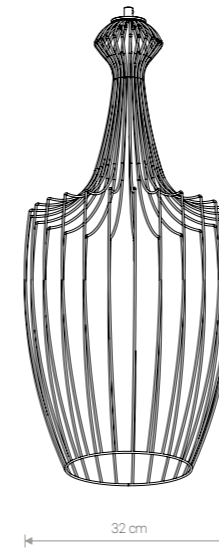

CAMELEON LUKSOR L

painted steel / stal lakierowana / лакированная сталь

8593 ● BL

works with / zastosuj z / применять с

Ⓛ 1× CAMELEON CABLE E27

electroplated brass / stal mosiądzowana / латунная сталь

8592 ● G

works with / zastosuj z / применять с

Ⓛ 1× CAMELEON CABLE E27

CAMELEON LUKSOR L
8593 BL

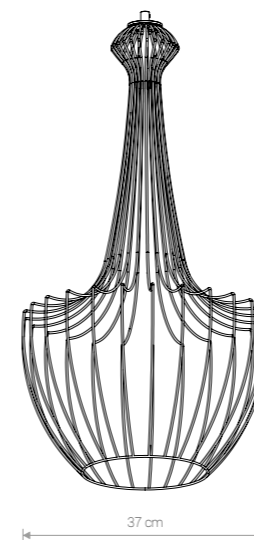

CAMELEON LUKSOR S

painted steel / stal lakierowana / лакированная сталь

8597 ● BL

works with / zastosuj z / применять с

Ⓛ 1× CAMELEON CABLE E27

electroplated brass / stal mosiądzowana / латунная сталь

8596 ● G

works with / zastosuj z / применять с

Ⓛ 1× CAMELEON CABLE E27

CAMELEON LUKSOR S
8597 BL





CAMELEON PICO A
8591 BL/G



CAMELEON PICO B
8590 BL/G



CAMELEON PICO C
8588 BL/G



CAMELEON ABI M
8582 BL



CAMELEON ABI S
8586 BL



CAMELEON ABI L
8577 BL

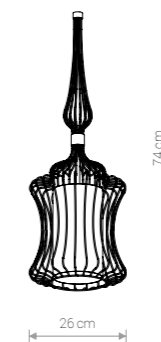
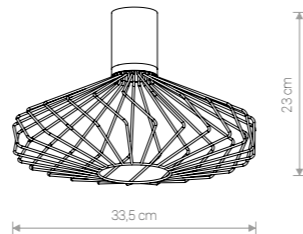
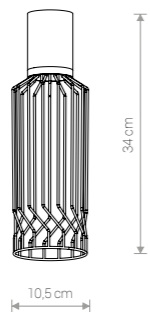
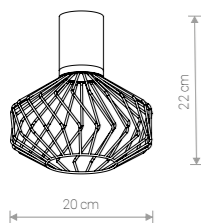

CAMELEON PICO A

painted steel, electroplated brass / stal lakierowana, stal mosiądzowana / лакированная сталь, латунная сталь

8591 ● BL/G

works with / zastosuj z / применять с

Ⓢ 1× CAMELEON CABLE GU10

CAMELEON PICO B

painted steel, electroplated brass / stal lakierowana, stal mosiądzowana / лакированная сталь, латунная сталь

8590 ● BL/G

works with / zastosuj z / применять с

Ⓢ 1× CAMELEON CABLE GU10

CAMELEON PICO C

painted steel, electroplated brass / stal lakierowana, stal mosiądzowana / лакированная сталь, латунная сталь

8588 ● BL/G

works with / zastosuj z / применять с

Ⓢ 1× CAMELEON CABLE GU10

CAMELEON ABI M

painted steel, shade / stal lakierowana, abażur / лакированная сталь, абажур

8584 ○ WH 8582 ● BL

works with / zastosuj z / применять с

Ⓢ 1× CAMELEON CABLE E27

CAMELEON ABI S

painted steel, shade / stal lakierowana, abażur / лакированная сталь, абажур

8587 ○ WH 8586 ● BL

works with / zastosuj z / применять с

Ⓢ 1× CAMELEON CABLE E27

CAMELEON ABI L

painted steel, shade / stal lakierowana, abażur / лакированная сталь, абажур

8581 ○ WH 8577 ● BL

works with / zastosuj z / применять с

Ⓢ 1× CAMELEON CABLE E27



CAMELEON
CANOPY F
8547 BL

CAMELEON UMBRELLA
8575 G/BL



CAMELEON UMBRELLA
8574 BL

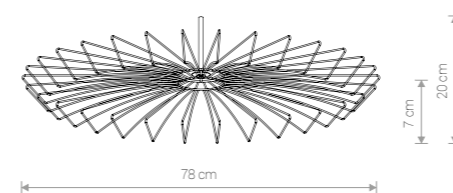

CAMELEON UMBRELLA

electroplated brass, painted steel /
stal miedzowana, stal lakierowana /
латунная сталь, лакированная сталь

8575 ● G/BL

works with / zastosuj z /
применять с

Ⓢ 1× CAMELEON CABLE E27



CAMELEON GSTAR
8576 G/BL

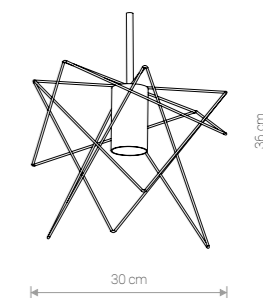

CAMELEON GSTAR

electroplated brass, painted steel /
stal miedzowana, stal lakierowana /
латунная сталь, лакированная сталь

8576 ● G/BL

works with / zastosuj z /
применять с

Ⓢ 1× CAMELEON CABLE GU10



CAMELEON EGG M
8607 BL/G

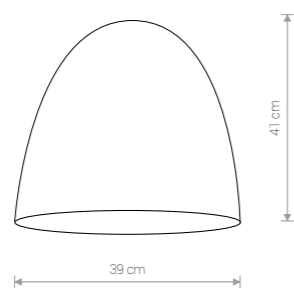

CAMELEON EGG M

composite / kompozyt / композитный

8607  BL/G

works with / zastosuj z /
применять с

 1x CAMELEON CABLE E27



**CAMELEON
CANOPY B 780**
8561 BL

CAMELEON EGG M
8607 BL/G

**CAMELEON
LASER 490**
 painted steel / stal lakierowana /
 лакированная сталь
 8573 ○ WH 8572 ● BL
 works with / zastosuj z /
 применять с
 1× CAMELEON CABLE G9



brass / miedz / латунь
 8571 ● BS
 works with / zastosuj z /
 применять с
 1× CAMELEON CABLE G9

**CAMELEON
LASER 750**
 painted steel / stal lakierowana /
 лакированная сталь
 8570 ○ WH 8568 ● BL
 works with / zastosuj z /
 применять с
 1× CAMELEON CABLE G9



brass / miedz / латунь
 8567 ● BS
 works with / zastosuj z /
 применять с
 1× CAMELEON CABLE G9

**CAMELEON
LASER 1000**
 painted steel / stal lakierowana /
 лакированная сталь
 8488 ○ WH 8487 ● BL
 works with / zastosuj z /
 применять с
 1× CAMELEON CABLE G9



brass / miedz / латунь
 8486 ● BS
 works with / zastosuj z /
 применять с
 1× CAMELEON CABLE G9



**CAMELEON
LASER 490**
8573 WH

**CAMELEON
LASER 750**
8568 BL

**CAMELEON
LASER 1000**
8486 BS



**CAMELEON
CANOPY C 780**
8556 BL

**CAMELEON
LASER 750**
8567 BS



CAMELEON EYE L
8484 BS



CAMELEON EYE M
8485 BS

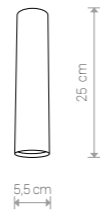

CAMELEON EYE M

brass / miedz / латунь

8485 ● BS

works with / zastosuj z /
применять с

Ⓛ 1× CAMELEON CABLE GU10

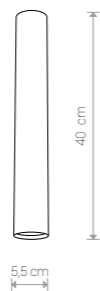

CAMELEON EYE L

brass / miedz / латунь

8484 ● BS

works with / zastosuj z /
применять с

Ⓛ 1× CAMELEON CABLE GU10

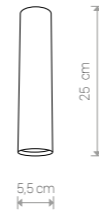

CAMELEON EYE M

painted steel / stal lakierowana /
лакированная сталь

8483 ○ WH 8478 ○ SI

8476 ● GR 8481 ● BL

works with / zastosuj z /
применять с

Ⓛ 1× CAMELEON CABLE GU10



CAMELEON EYE L

painted steel / stal lakierowana /
лакированная сталь

8482 ○ WH 8477 ○ SI

8475 ● GR 8480 ● BL

works with / zastosuj z /
применять с

Ⓛ 1× CAMELEON CABLE GU10



CAMELEON EYE M
8478 SI



CAMELEON EYE L
8475 GR



CAMELEON EYE L
8482 WH



CAMELEON POLY L
8472 WH



CAMELEON POLY M
8473 BL

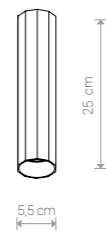

CAMELEON POLY M

painted aluminum / aluminium lakierowane /
лакированный алюминий

8474 ○ WH 8473 ● BL

works with / zastosuj z /
применять с

Ⓛ 1× CAMELEON CABLE GU10



CAMELEON POLY L

painted aluminum / aluminium lakierowane /
лакированный алюминий

8472 ○ WH 8471 ● BL

works with / zastosuj z /
применять с

Ⓛ 1× CAMELEON CABLE GU10



CAMELEON TULUM
8467 CN



CAMELEON TULUM
8426 CN

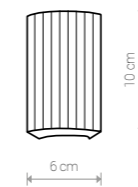

CAMELEON TULUM

concrete / beton / бетон

8467 ● CN

works with / zastosuj z /
применять с

Ⓛ 1× CAMELEON CABLE E27

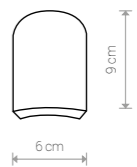

CAMELEON TULUM

concrete / beton / бетон

8426 ● CN

works with / zastosuj z /
применять с

Ⓛ 1× CAMELEON CABLE E27



CAMELEON GEOMETRIC
8465 CN

CAMELEON GEOMETRIC
8466 CN



CAMELEON GEOMETRIC
8466 CN



CAMELEON GEOMETRIC
8425 CN



CAMELEON GEOMETRIC
8465 CN

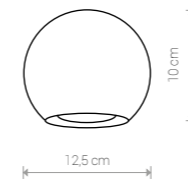

**CAMELEON
GEOMETRIC**

concrete / beton / бетон

8466 ● CN

works with / zastosuj z /
применять с

Ⓛ 1× CAMELEON CABLE GU10

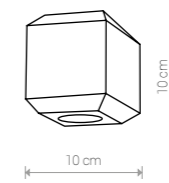

**CAMELEON
GEOMETRIC**

concrete / beton / бетон

8425 ● CN

works with / zastosuj z /
применять с

Ⓛ 1× CAMELEON CABLE GU10

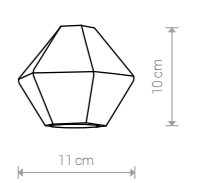

**CAMELEON
GEOMETRIC**

concrete / beton / бетон

8465 ● CN

works with / zastosuj z /
применять с

Ⓛ 1× CAMELEON CABLE GU10

**CAMELEON
CANOPY G**
8361 WH

CAMELEON CYLINDER M
8542 TR/WH

This arrangement was made of elements from PROFILE TRACK system that is presented in Nowodvorski Lighting 2019/20 catalogue.

Na aranżacji wykorzystano element systemu **PROFILE TRACK** znajdujący się w ofercie prezentowanej w Katalogu 2019/2020.

В данной визуализации использованы элементы системы **PROFILE TRACK**, которая представлена в каталоге 2019/20.



CAMELEON CYLINDER L
8540 TR/BS

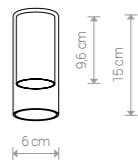

CAMELEON CYLINDER S

glass, painted steel / szkło, stal laskierowana /
стекло, лакированная сталь

8544 ● TR/BL 8545 ○ TR/WH

works with / zastosuj z /
применять с

1x CAMELEON CABLE GU10

glass, brass / szkło, miedz /
стекло, латунь

8546 ● TR/BS

works with / zastosuj z /
применять с

1x CAMELEON CABLE GU10



CAMELEON CYLINDER S
8544 TR/BL

CAMELEON CYLINDER M
8542 TR/WH

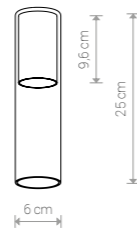

CAMELEON CYLINDER M

glass, painted steel / szkło, stal laskierowana /
стекло, лакированная сталь

8541 ● TR/BL 8542 ○ TR/WH

works with / zastosuj z /
применять с

1x CAMELEON CABLE GU10

glass, brass / szkło, miedz /
стекло, латунь

8543 ● TR/BS

works with / zastosuj z /
применять с

1x CAMELEON CABLE GU10

1 x GU10 not included

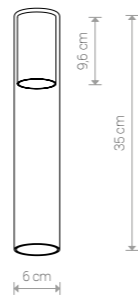

CAMELEON CYLINDER L

glass, painted steel / szkło, stal laskierowana /
стекло, лакированная сталь

8537 ● TR/BL 8538 ○ TR/WH

works with / zastosuj z /
применять с

1x CAMELEON CABLE GU10

glass, brass / szkło, miedz /
стекло, латунь

8540 ● TR/BS

works with / zastosuj z /
применять с

1x CAMELEON CABLE GU10

1 x G9 not included

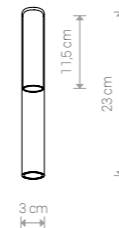

CAMELEON STRAW S

glass, painted steel / szkło, stal laskierowana /
стекло, лакированная сталь

8400 ● TR/BL 8536 ○ TR/WH

works with / zastosuj z /
применять с

1x CAMELEON CABLE G9

glass, brass / szkło, miedz /
стекло, латунь

8401 ● TR/BS

works with / zastosuj z /
применять с

1x CAMELEON CABLE G9

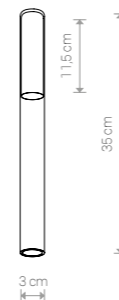

CAMELEON STRAW M

glass, painted steel / szkło, stal laskierowana /
стекло, лакированная сталь

8402 ● TR/BL 8535 ○ TR/WH

works with / zastosuj z /
применять с

1x CAMELEON CABLE G9

glass, brass / szkło, miedz /
стекло, латунь

8403 ● TR/BS

works with / zastosuj z /
применять с

1x CAMELEON CABLE G9



CAMELEON STRAW S
8536 TR/WH

CAMELEON STRAW M
8402 TR/BL





CAMELEON PEAR S
8534 TR/G

CAMELEON PEAR M
8533 TR/G

CAMELEON PEAR L
8532 TR/G

**CAMELEON
CANOPY A**
8563 BL

**CAMELEON
CABLE WITH
SWITCH**
8611 BL



CAMELEON PEAR S
8534 TR/G

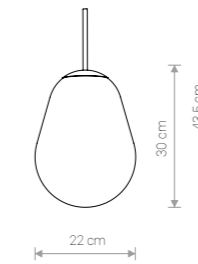

CAMELEON PEAR S

glass, electroplated brass / szkło, stal mosiądzowana /
стекло, латунная сталь

8534 TR/G

works with / zastosuj z /
применять с

1 × CAMELEON CABLE E27

1 × CAMELEON CABLE G9



CAMELEON PEAR M
8533 TR/G

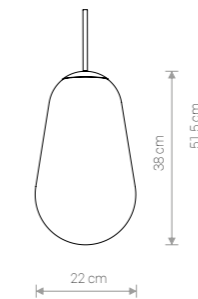

CAMELEON PEAR M

glass, electroplated brass / szkło, stal mosiądzowana /
стекло, латунная сталь

8533 TR/G

works with / zastosuj z /
применять с

1 × CAMELEON CABLE E27

1 × CAMELEON CABLE G9



CAMELEON PEAR L
8532 TR/G

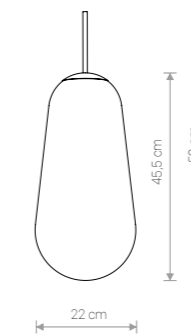

CAMELEON PEAR L

glass, electroplated brass / szkło, stal mosiądzowana /
стекло, латунная сталь

8532 TR/G

works with / zastosuj z /
применять с

1 × CAMELEON CABLE E27

1 × CAMELEON CABLE G9



CAMELEON SPHERE S
8531 TR



CAMELEON SPHERE M
8530 TR



CAMELEON SPHERE L
8528 TR



CAMELEON SPHERE XL
8527 TR

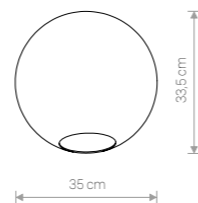
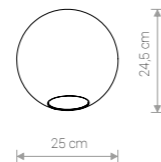
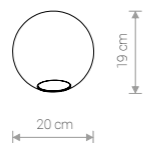
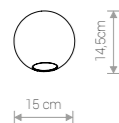

CAMELEON SPHERE S

glass / szkło / стекло

8531 ○ TR

works with / zastosuj z /
применять с

Ⓢ 1× CAMELEON CABLE G9

CAMELEON SPHERE M

glass / szkło / стекло

8530 ○ TR

works with / zastosuj z /
применять с

Ⓢ 1× CAMELEON CABLE E27

Ⓢ 1× CAMELEON CABLE G9

CAMELEON SPHERE L

glass / szkło / стекло

8528 ○ TR

works with / zastosuj z /
применять с

Ⓢ 1× CAMELEON CABLE E27

Ⓢ 1× CAMELEON CABLE G9

CAMELEON SPHERE XL

glass / szkło / стекло

8527 ○ TR

works with / zastosuj z /
применять с

Ⓢ 1× CAMELEON CABLE E27

Ⓢ 1× CAMELEON CABLE G9



CAMELEON SPHERE XL
8527 TR

CAMELEON SPHERE L
8528 TR

CAMELEON SPHERE M
8530 TR

CAMELEON SPHERE S
8531 TR



CAMELEON BIO
8458 NT



CAMELEON BIO
8461 WH



CAMELEON
CANOPY B 1500
8560 WH

CAMELEON DOVER
8464 NT

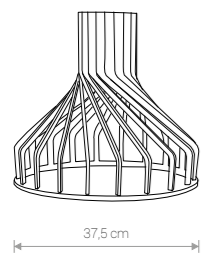

CAMELEON
BIO S

plywood / sklejka / дерево

8458 ● NT 8457 ○ WH

works with / zastosuj z /
применять с

Ⓛ 1× CAMELEON CABLE E27

Ⓛ 1× CAMELEON CABLE GU10

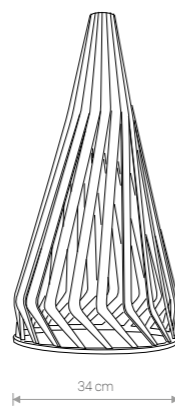

CAMELEON
BIO M

plywood / sklejka / дерево

8462 ● NT 8461 ○ WH

works with / zastosuj z /
применять с

Ⓛ 1× CAMELEON CABLE E27

Ⓛ 1× CAMELEON CABLE GU10

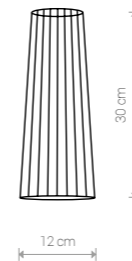

CAMELEON
DOVER

plywood / sklejka / дерево

8464 ● NT 8463 ● BL

works with / zastosuj z /
применять с

Ⓛ 1× CAMELEON CABLE GU10



CAMELEON DOVER
8463 BL

CAMELEON DOVER
8464 NT



CAMELEON WHEEL
8424 G

CAMELEON WHEEL
8423 BL

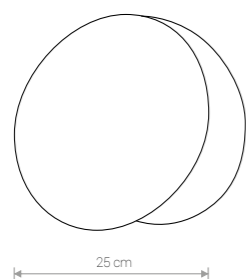

25 cm

CAMELEON WHEEL

plywood, painted steel / sklejka, stal lakierowana /
дерево, лакирована сталь

8424  G 8423  BL

works with / zastosuj z /
применять с

 1x CAMELEON CABLE E27

CAMELEON WHEEL
8423 BL



CAMELEON WHEEL
8424 G



CAMELEON CANOPY B 1500
8558 BL

CAMELEON CONE M
8411 BL/G

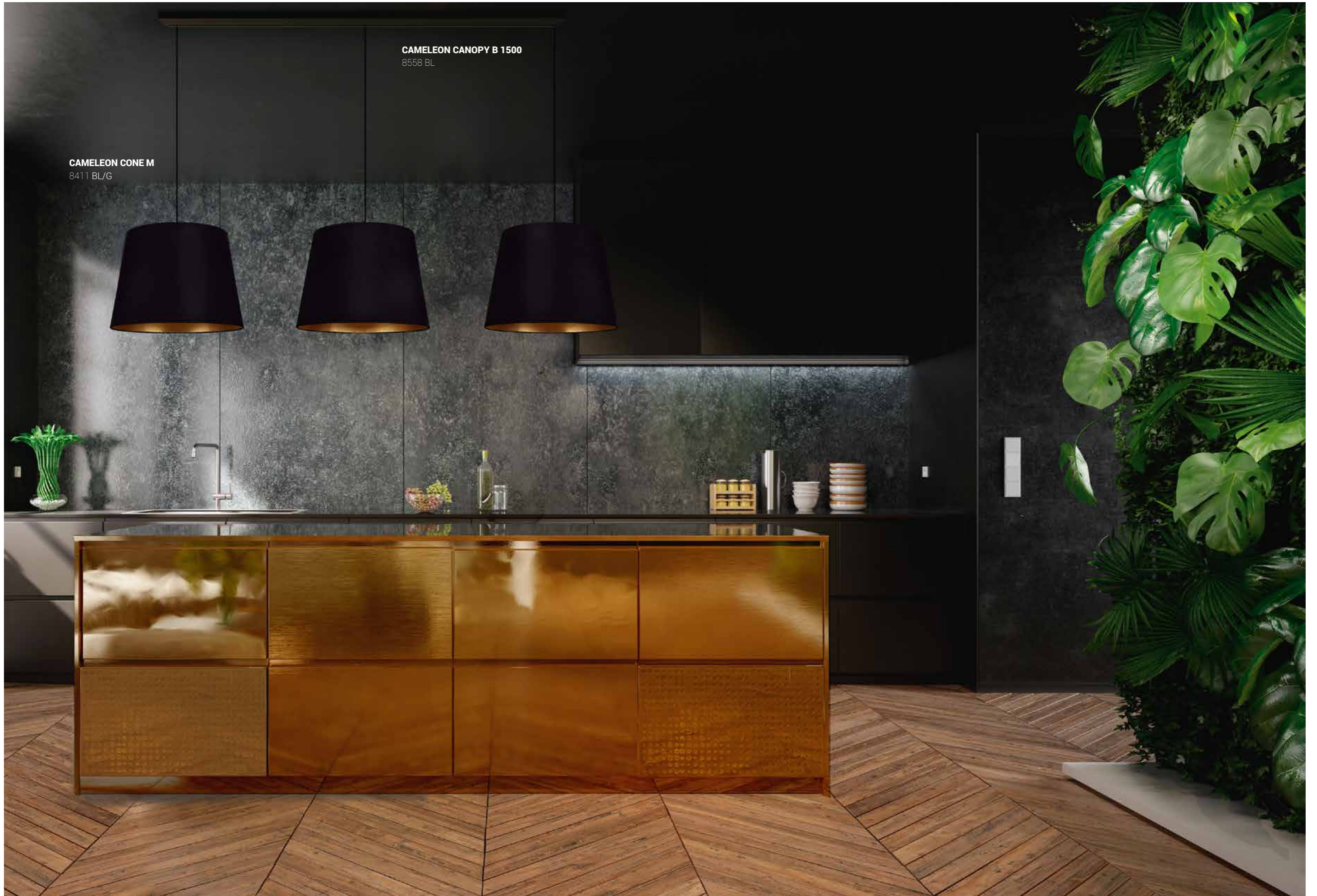

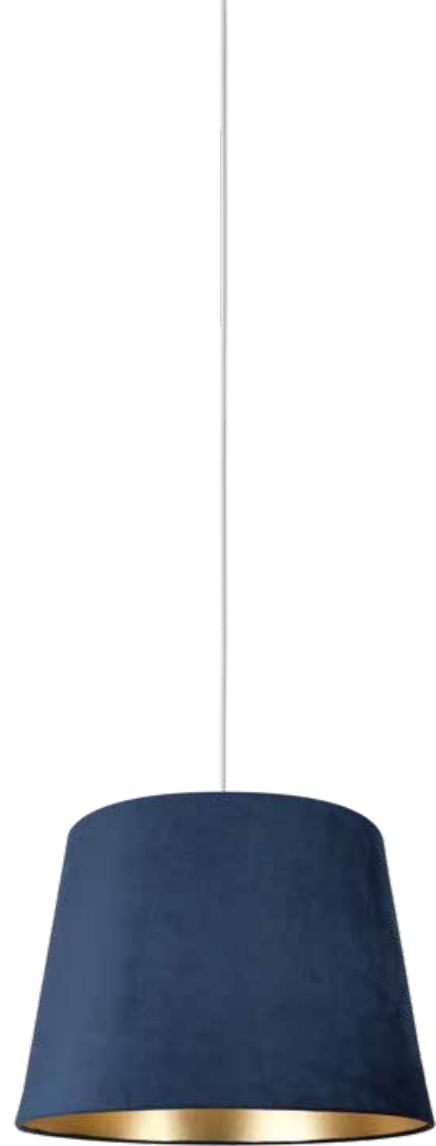

CAMELEON CONE M
8497 V NB/G



CAMELEON CONE M
8411 BL/G



CAMELEON CONE M
8414 V GN/G



CAMELEON CONE L
8494 V PI/WH



CAMELEON CONE L
8408 WH



CAMELEON CONE L
8491 V BL

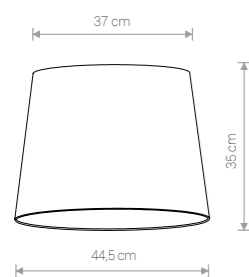

CAMELEON CONE M

shade / abażur / абажур

8498 ● V PI/WH 8497 ● V NB/G 8414 ● V GN/G 8496 ○ V WH 8495 ● V BL

8412 ● GY 8411 ● BL/G 8413 ○ WH

works with / zastosuj z /
применять с

1x CAMELEON CABLE E27

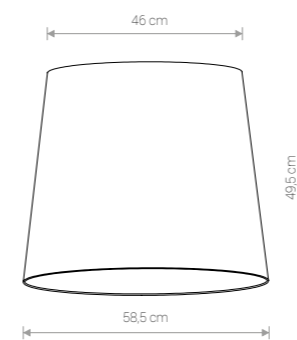

CAMELEON CONE L

shade / abażur / абажур

8494 ● V PI/WH 8493 ● V NB/G 8410 ● V GN/G 8492 ○ V WH 8491 ● V BL

8407 ● GY 8406 ● BL/G 8408 ○ WH

works with / zastosuj z /
применять с

1x CAMELEON CABLE E27



CAMELEON CONE S
8502 V PI/WH

CAMELEON CONE S
8503 V GN/G

CAMELEON CONE S
8501 V NB/G

CAMELEON CONE S
8504 BL/G

CAMELEON CONE S
8415 V BL

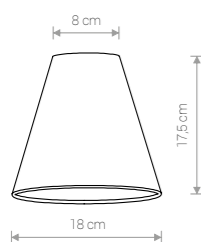

CAMELEON CONE S

shade / abażur / абажур

8502 V PI/WH 8501 V NB/G 8503 V GN/G 8500 V WH 8415 V BL

8505 GY 8504 BL/G 8416 WH

works with / zastosuj z /
применять с

- 1x CAMELEON CABLE E27
- 1x CAMELEON CABLE GU10
- 1x CAMELEON CABLE G9

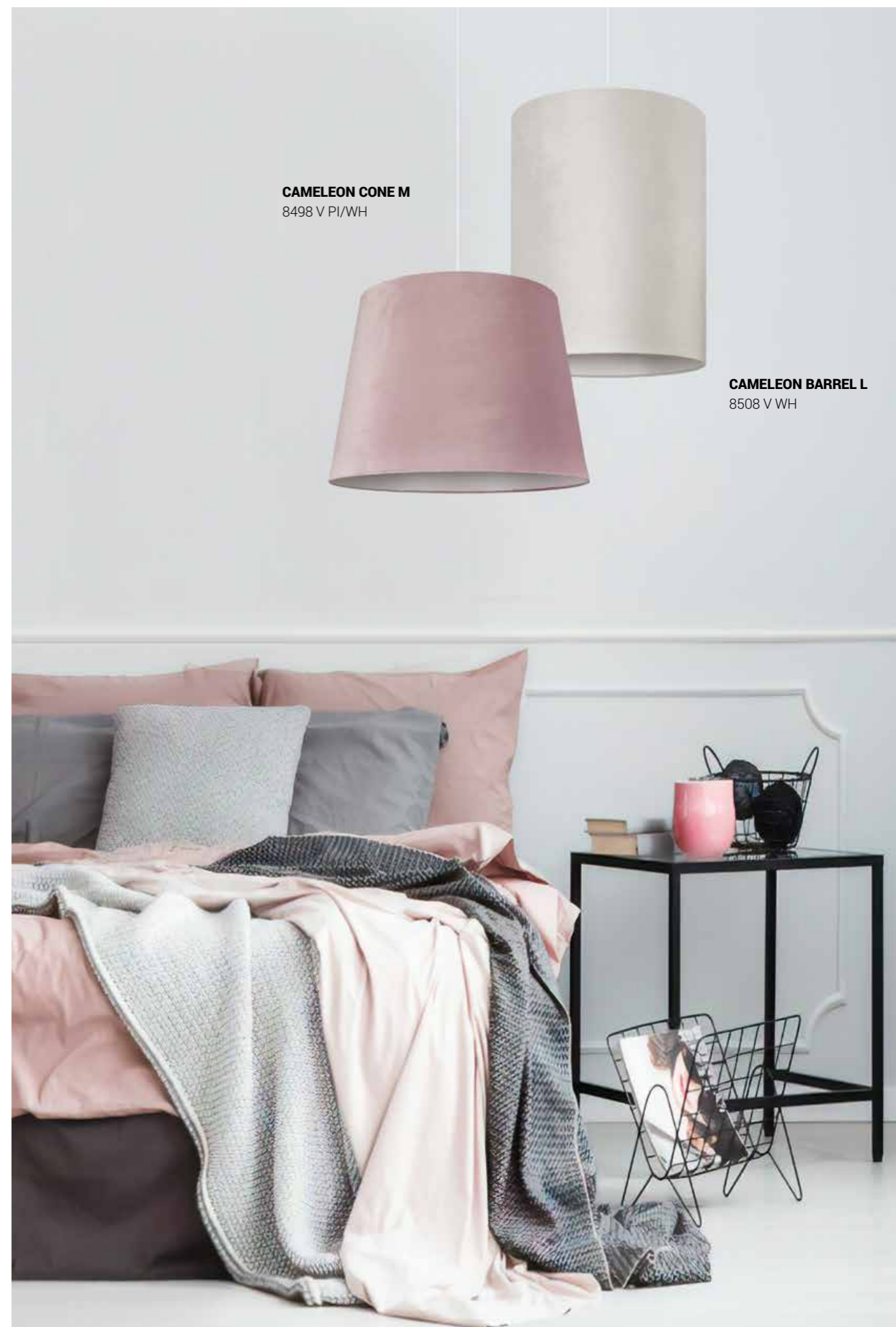

CAMELEON CONE M
8498 V PI/WH

CAMELEON BARREL L
8508 V WH

**CAMELEON
CANOPY A**
8563 BL

**CAMELEON
BARREL WIDE S**
8512 V GN/G

**CAMELEON
BARREL L**
8417 V GN/G





**CAMELEON
BARREL WIDE S**
8518 WH



**CAMELEON
BARREL WIDE S**
8517 GY



**CAMELEON
BARREL WIDE S**
8515 V PI/WH



**CAMELEON
BARREL WIDE S**
8514 V NB/G



**CAMELEON
BARREL THIN S**
8520 V GN/G



**CAMELEON
BARREL THIN S**
8422 V BL



**CAMELEON
BARREL THIN S**
8522 V NB/G



**CAMELEON
BARREL THIN S**
8521 V WH

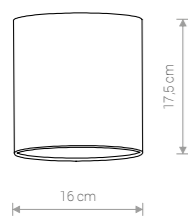

CAMELEON BARREL WIDE S

shade / abażur / абажур

8515 V PI/WH 8514 V NB/G 8512 V GN/G 8513 V WH 8421 V BL

8517 GY 8516 BL/G 8518 WH

works with / zastosuj z /
применять с

1x CAMELEON CABLE E27

1x CAMELEON CABLE GU10

1x CAMELEON CABLE G9

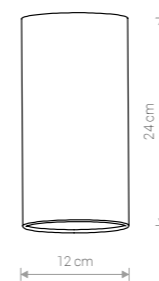

CAMELEON BARREL THIN S

shade / abażur / абажур

8523 V PI/WH 8522 V NB/G 8520 V GN/G 8521 V WH 8422 V BL

8525 GY 8524 BL/G 8526 WH

works with / zastosuj z /
применять с

1x CAMELEON CABLE E27

1x CAMELEON CABLE GU10

1x CAMELEON CABLE G9

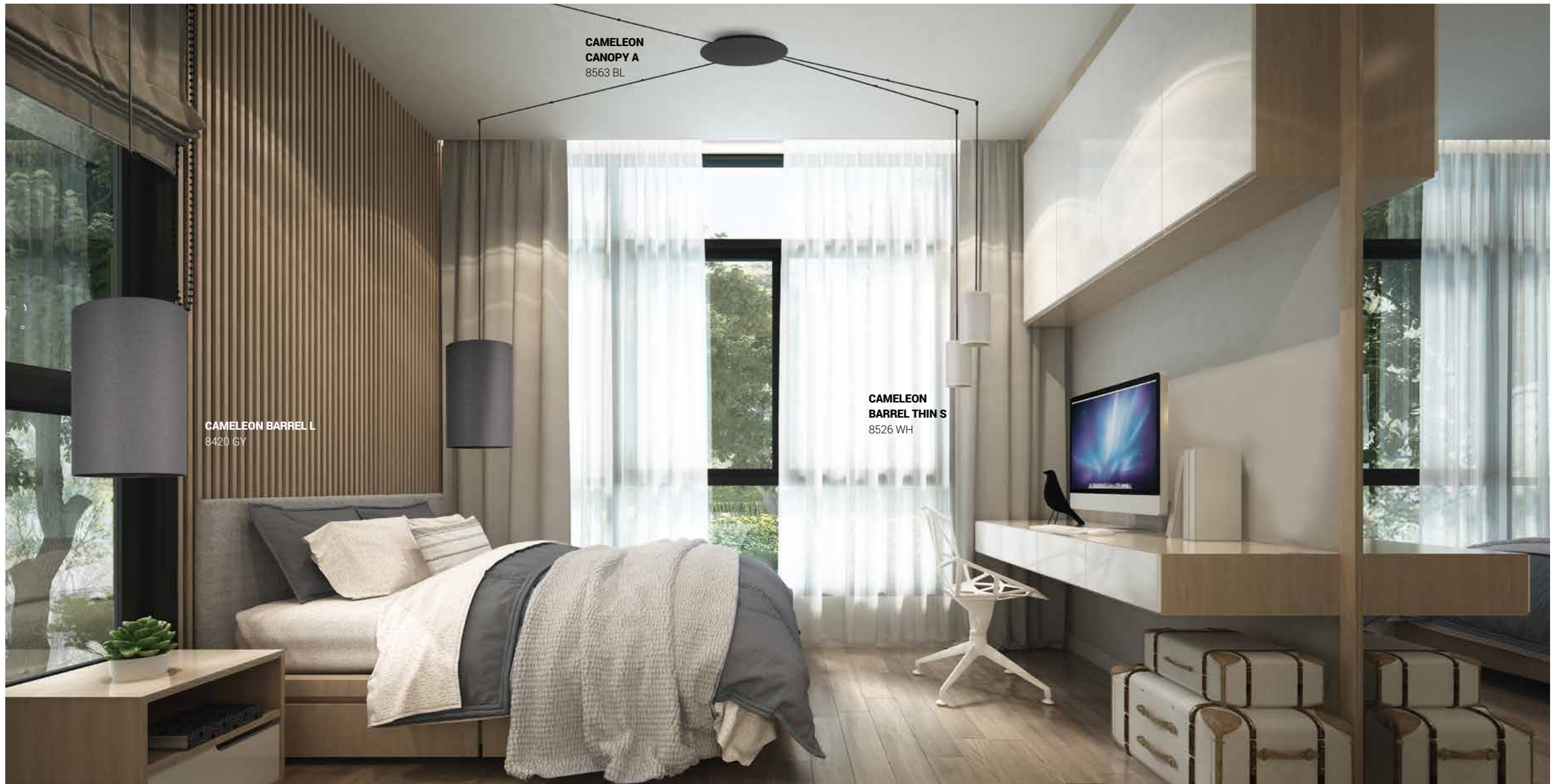

**CAMELEON
CANOPY A**
8563 BL

CAMELEON BARREL L
8420 GY

**CAMELEON
BARREL THIN S**
8526 WH

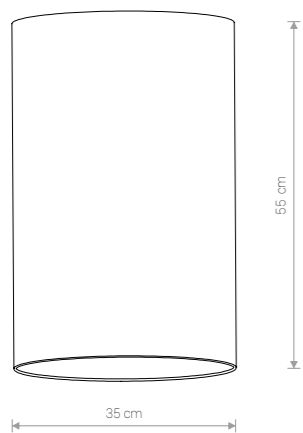

**CAMELEON
BARREL L**

shade / abażur / абажур

- 8511 V PI/WH
- 8510 V NB/G
- 8417 V GN/G
- 8508 V WH
- 8507 V BL

- 8420 GY
- 8418 BL/G
- 8506 WH

works with / zastosuj z /
применить с

1x CAMELEON CABLE E27



CAMELEON BARREL L
8420 GY

CAMELEON BARREL L
8506 WH



**CAMELEON
CANOPY B 1500**
8608 BL

CAMELEON H LED
8454 WH/BL



CAMELEON H LED
8454 WH/BL

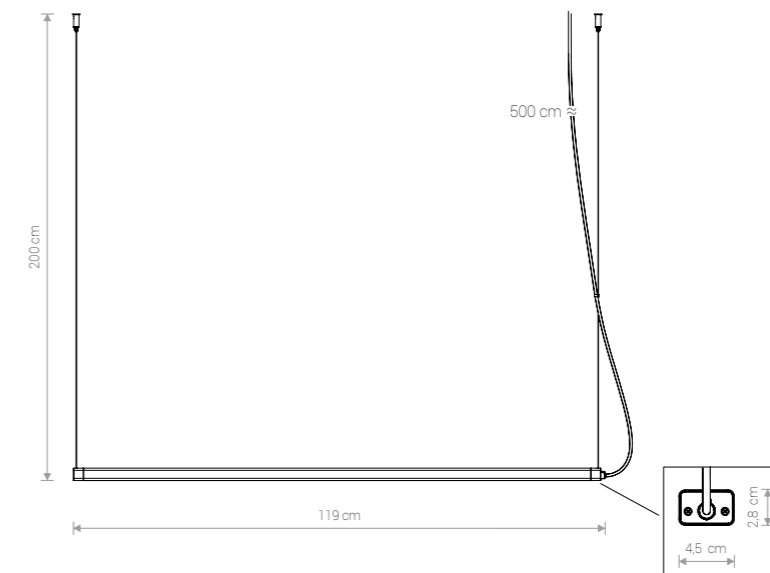

CAMELEON H LED

painted steel, PC / stal lakierowana, PC /
лакированная сталь, PC

8455 ○ WH 8454 ● WH/BL

36W LED

works with / zastosuj z / применять с

A (8566 WH, 8564 BL), B (8610 WH, 8608 BL)
E (8551 WH, 8550 BL), F (8548 WH, 8547 BL)

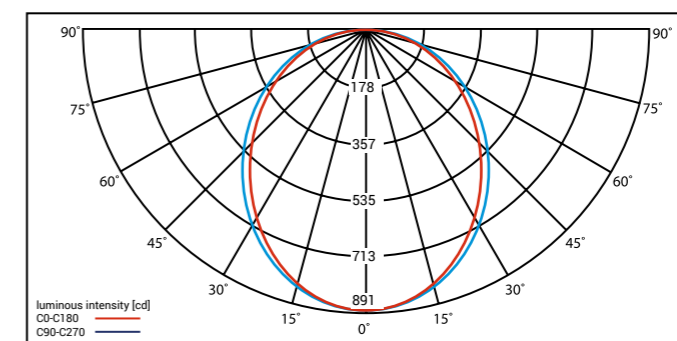

Beam cone diagram - 8455 WH, 8454 WH/BL

Item No.	INPUT POWER	COLOUR TEMP.	LUMINOUS FLUX	LUMINAIRE EFFICIENCY	COLOUR RENDERING INDEX (CRI ≥)	INPUT	LIFETIME
8455, 8454	36 W LED	3000K	2300 lm	65 lm/W	80	~230V, 50Hz	50 000 h

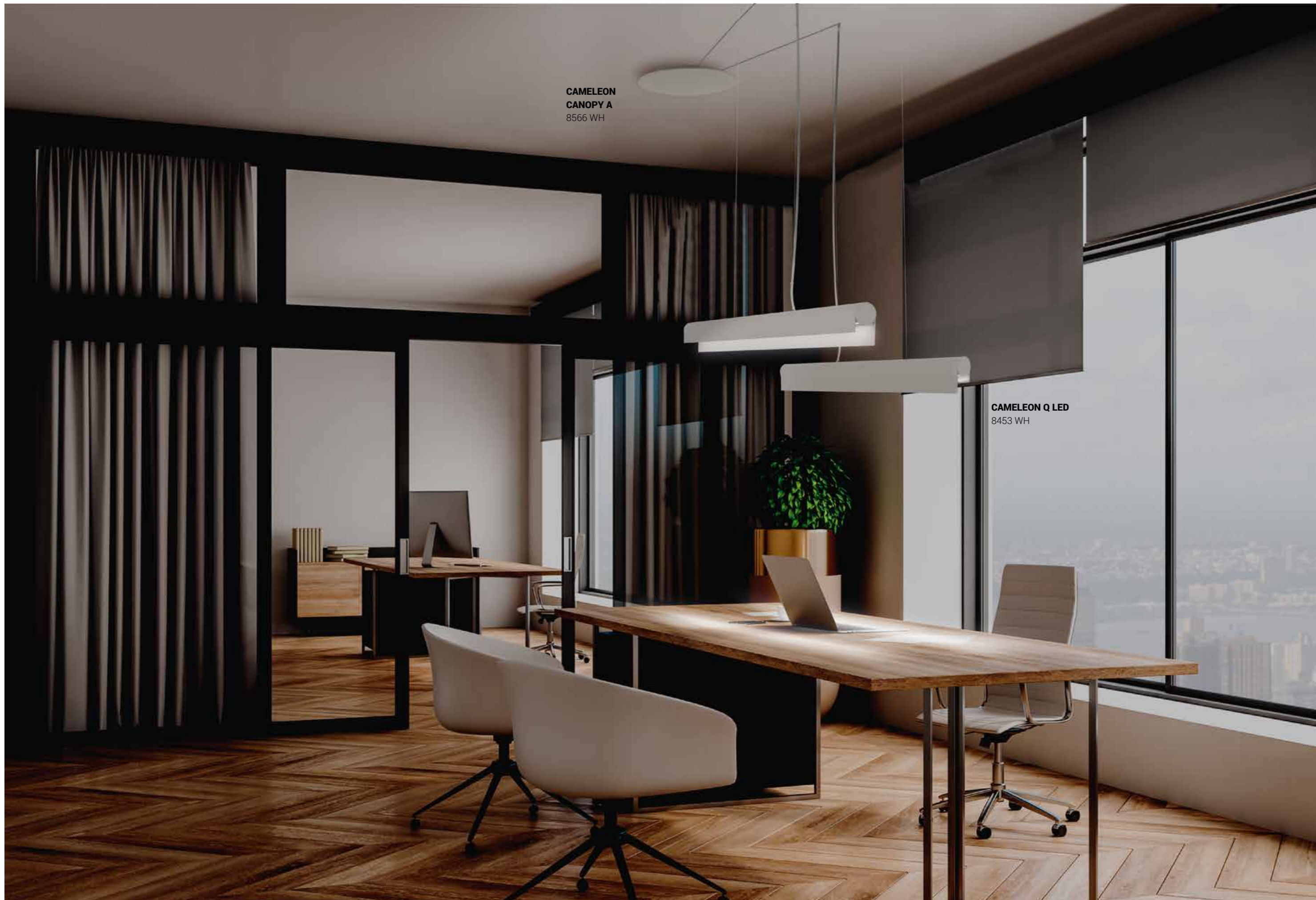

**CAMELEON
CANOPY A**
8566 WH

CAMELEON Q LED
8453 WH



CAMELEON A LED
8451 WH

CAMELEON A LED

painted steel, PC / stal lakierowana, PC / лакированная сталь, PC

8451 ○ WH 8450 ● BL

36W LED

works with / zastosuj z / применять с

A (8566 WH, 8564 BL), B (8610 WH, 8608 BL)
E (8551 WH, 8550 BL), F (8548 WH, 8547 BL)

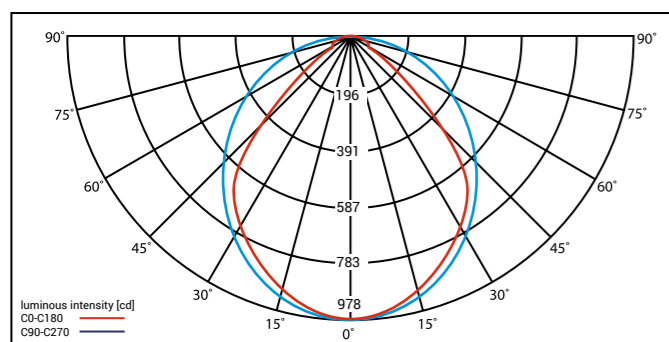
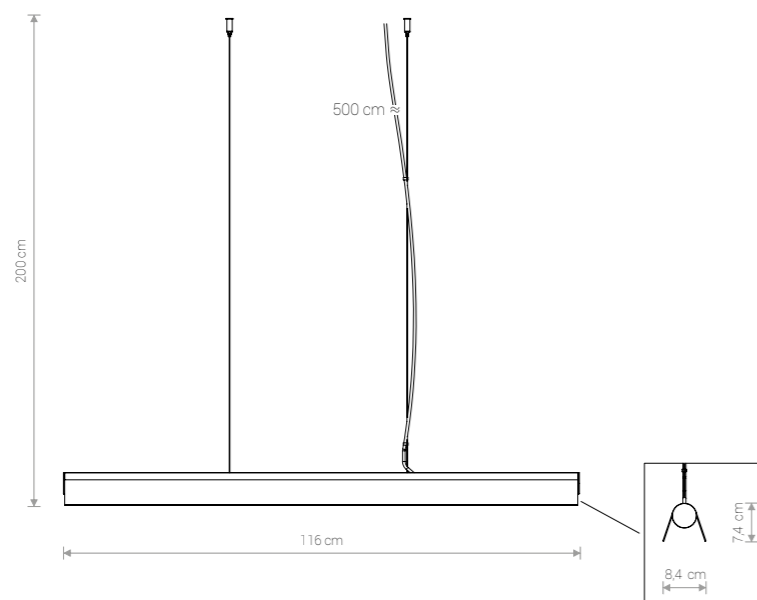

Beam cone diagram - 8451 WH

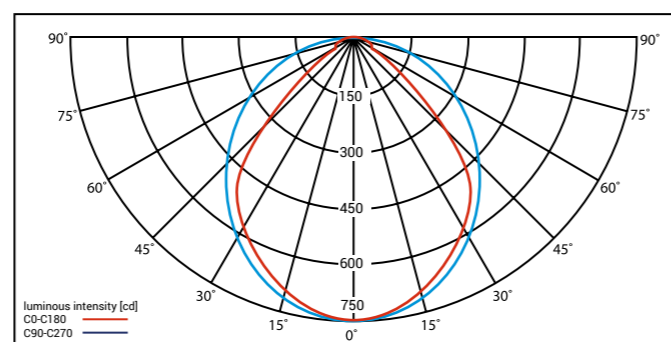

Beam cone diagram - 8450 BL

Item No.	INPUT POWER	COLOUR TEMP.	LUMINOUS FLUX	LUMINAIRE EFFICIENCY	COLOUR RENDERING INDEX (CRI ≥)	INPUT	LIFETIME
8451	36 W LED	3000K	2200 lm	60 lm/W	80	~230V, 50Hz	50 000 h
8450	36 W LED	3000K	1500 lm	40 lm/W	80	~230V, 50Hz	50 000 h



reddot design award
winner 2019

CAMELEON Q LED
8452 BL

CAMELEON Q LED

painted steel, PC / stal lakierowana, PC / лакированная сталь, PC

8453 ○ WH 8452 ● BL

36W LED

works with / zastosuj z / применять с

A (8566 WH, 8564 BL), B (8610 WH, 8608 BL)
E (8551 WH, 8550 BL), F (8548 WH, 8547 BL)

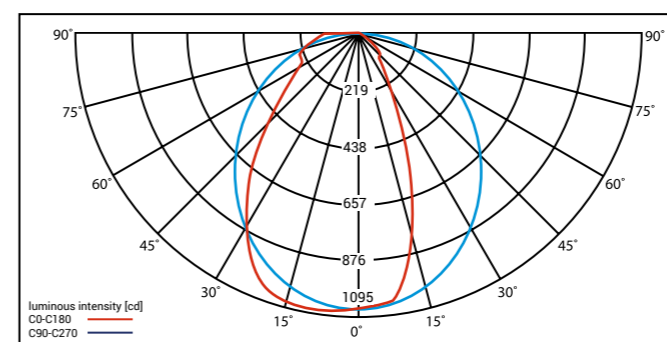
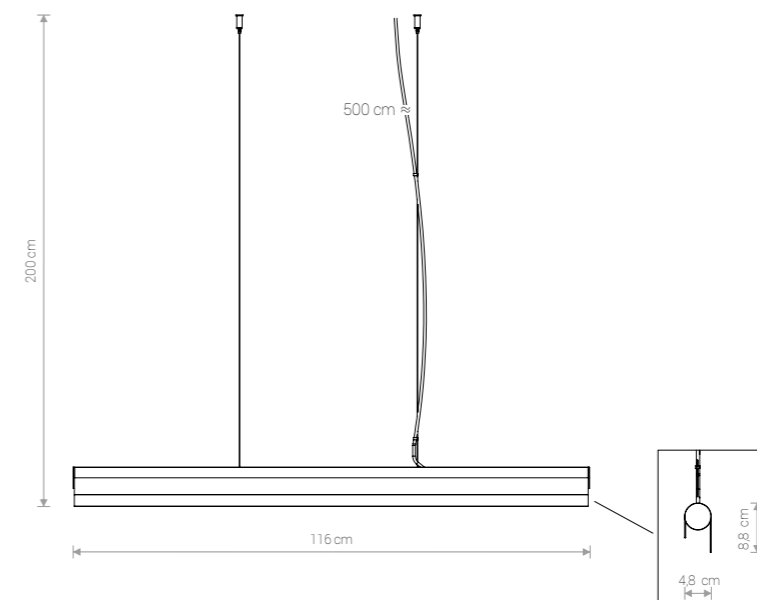

Beam cone diagram - 8453 WH

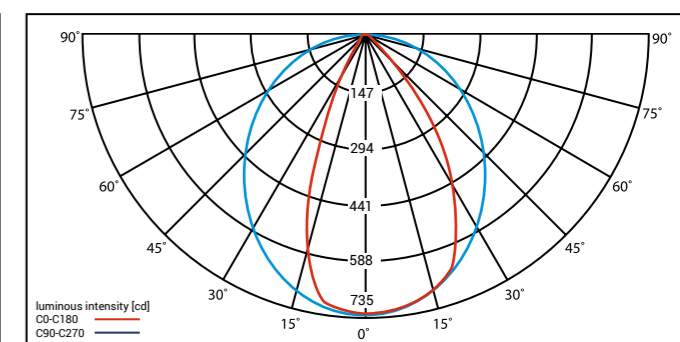

Beam cone diagram - 8452 BL

Item No.	INPUT POWER	COLOUR TEMP.	LUMINOUS FLUX	LUMINAIRE EFFICIENCY	COLOUR RENDERING INDEX (CRI ≥)	INPUT	LIFETIME
8453	36 W LED	3000K	2100 lm	60 lm/W	80	~230V, 50Hz	50 000 h
8452	36 W LED	3000K	1100 lm	30 lm/W	80	~230V, 50Hz	50 000 h

CAMELEON CABLE E27 | max 40W

silicone / silikon / Силикон



● BL

LENGHT	ITEM NO.
1,5 m	8670
2,5 m	8667
3,5 m	8668
5 m	8664
7 m	8663

silicone / silikon / Силикон



○ WH

LENGHT	ITEM NO.
1,5 m	8654
2,5 m	8652
3,5 m	8653
5 m	8648
7 m	8647

silicone / silikon / Силикон



● BL/BS

LENGHT	ITEM NO.
1,5 m	8666
2,5 m	8665
3,5 m	8662
5 m	8661
7 m	8660

silicone / silikon / Силикон



● BL/CH

LENGHT	ITEM NO.
1,5 m	8658
2,5 m	8657
3,5 m	8656
5 m	8655
7 m	8651

silicone / silikon / Силикон



○ WH/CH

LENGHT	ITEM NO.
1,5 m	8650
2,5 m	8646
3,5 m	8645
5 m	8644
7 m	8643

CAMELEON CABLE G9 | max 10W only LED

silicone / silikon / Силикон



● BL

LENGHT	ITEM NO.
1,5 m	8632
2,5 m	8631
3,5 m	8627
5 m	8626
7 m	8625

silicone / silikon / Силикон



○ WH

LENGHT	ITEM NO.
1,5 m	8640
2,5 m	8638
3,5 m	8637
5 m	8636
7 m	8634

silicone / silikon / Силикон



● BL/BS

LENGHT	ITEM NO.
1,5 m	8622
2,5 m	8621
3,5 m	8618
5 m	8616
7 m	8615

silicone / silikon / Силикон



● BL/CH

LENGHT	ITEM NO.
1,5 m	8601
2,5 m	8598
3,5 m	8623
5 m	8595
7 m	8594

silicone / silikon / Силикон



○ WH/CH

LENGHT	ITEM NO.
1,5 m	8585
2,5 m	8583
3,5 m	8624
5 m	8580
7 m	8578

CAMELEON CABLE GU10 | max 10W only LED

silicone / silikon / Силикон



● BL/CH

LENGHT	ITEM NO.
1,5 m	8635
2,5 m	8633
3,5 m	8641
5 m	8630
7 m	8628

silicone / silikon / Силикон



○ WH/CH

LENGHT	ITEM NO.
1,5 m	8620
2,5 m	8617
3,5 m	8642
5 m	8614
7 m	8613

CAMELEON CABLE WITH SWITCH

silicone / silikon / Силикон



8611 ● BL 8612 ○ WH

LENGHT	ITEM NO.
1,5 m	8611
1,5 m	8612

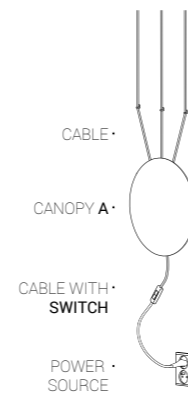

CAMELEON CANOPY

CAMELEON PUSZKA

CAMELEON OSNOWANIE

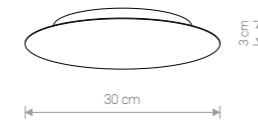

CANOPY A

painted steel, plastic / stal laskierowana, tworzywo sztuczne / лакированная сталь, пластик

works with / zastosuj z / применять с

Ⓧ MAX 8 lamps

8566 ○ WH 8564 ● BL

works with / zastosuj z / применять с

Ⓧ MAX 12 lamps

8565 ○ WH 8563 ● BL

application: wall / ceiling
zastosowanie: ściana / sufit
применение: стена / потолок



CANOPY D 780

painted steel / stal laskierowana / лакированная сталь

works with / zastosuj z / применять с

Ⓧ MAX 12 lamps

8552 ● BL 8553 ○ WH

application: wall / ceiling
zastosowanie: ściana / sufit
применение: стена / потолок

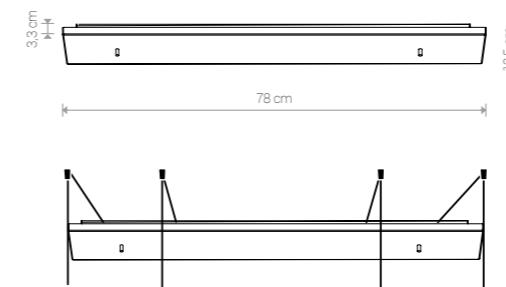

CAMELEON CANOPY

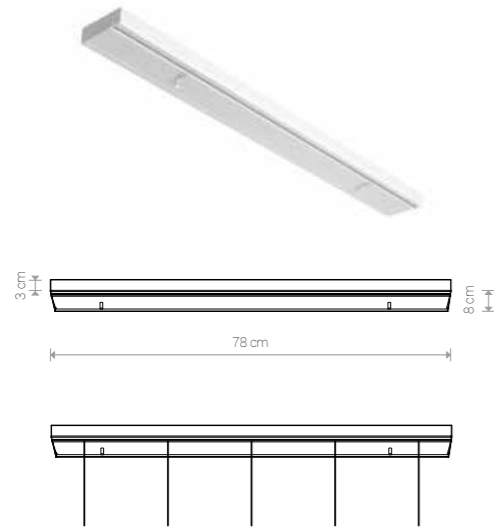

CAMELEON PUSZKA
CAMELEON OSNOVANIE



CANOPY B 780

painted steel / stal laskierowana /
лакированная сталь

works with / zastosuj z / применять с

MAX 12 lamps 
8562  WH 8561  BL

application: wall / ceiling
zastosowanie: sciana / sufit
применение: стена / потолок

CAMELEON CANOPY

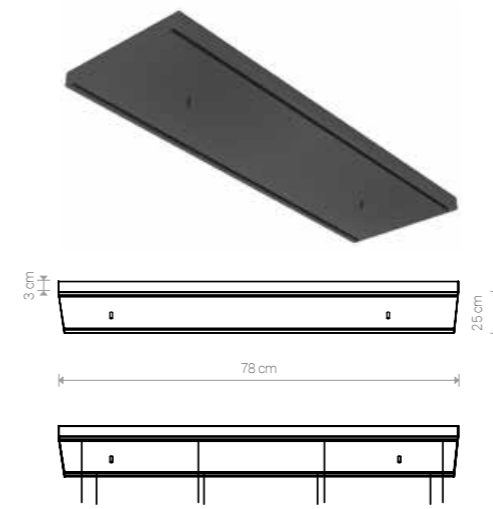

CAMELEON PUSZKA
CAMELEON OSNOVANIE



CANOPY C 780

painted steel / stal laskierowana /
лакированная сталь

works with / zastosuj z / применять с

MAX 12 lamps 
8556  BL 8557  WH



application: wall / ceiling
zastosowanie: sciana / sufit
применение: стена / потолок





CANOPY B 1500

painted steel, plastic / stal laskierowana, tworzywo sztuczne /
лакированная сталь, пластик

works with / zastosuj z / применять с

MAX 8 lamps 
8610  WH 8608  BL

works with / zastosuj z / применять с

MAX 12 lamps 
8560  WH 8558  BL

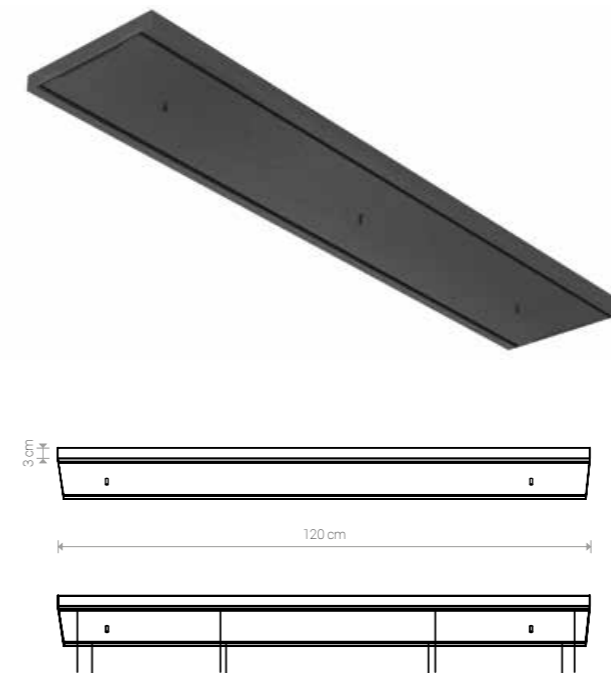

application: wall / ceiling
zastosowanie: sciana / sufit
применение: стена / потолок



CANOPY C 1200

painted steel / stal laskierowana /
лакированная сталь

works with / zastosuj z / применять с

MAX 12 lamps 
8554  BL 8555  WH

application: wall / ceiling
zastosowanie: sciana / sufit
применение: стена / потолок

CAMELEON CANOPY

CAMELEON PUSZKA
CAMELEON ОСНОВАНИЕ

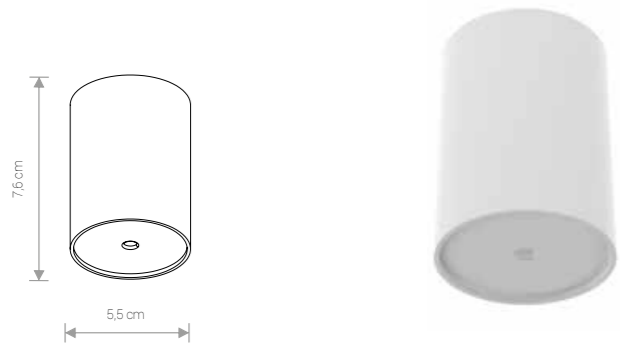

CANOPY E

painted steel / stal laskierowana / лакированная сталь

works with / zastosuj z / применять с

MAX 1 lamp
8551 ○ WH 8550 ● BL

application: wall / ceiling
zastosowanie: ściana / sufit
применение: стена / потолок

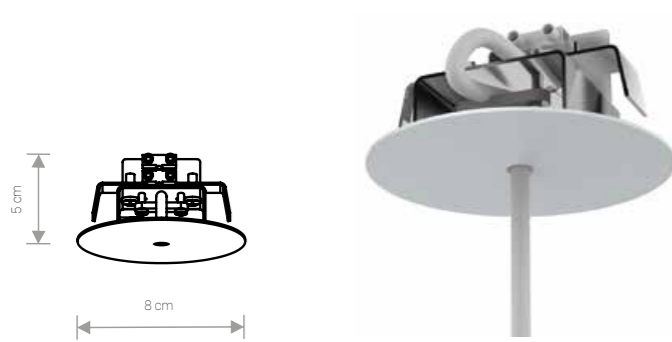

CANOPY F

painted steel / stal laskierowana / лакированная сталь

works with / zastosuj z / применять с

MAX 1 lamp
8548 ○ WH 8547 ● BL

application: wall / ceiling
zastosowanie: ściana / sufit
приложение: стена / потолок



CANOPY G

painted steel / stal laskierowana / лакированная сталь

works with / zastosuj z / применять с

MAX 1 lamp
8361 ○ WH 8360 ● BL

application: wall / ceiling
zastosowanie: ściana / sufit
приложение: стена / потолок

works with / zastosuj z / применять с

PROFILE TRACK system (Catalogue 2019/2020) /
PROFILE TRACK system (Katalog 2019/2020) /
система PROFILE TRACK (Catalogue 2019/2020)

CAMELEON FIXING

CAMELEON AKCESORIA MONTAŻOWE
CAMELEON АКССУАРЫ ДЛЯ КРЕПЛЕНИЯ



CAMELEON MOUNTING A

CAMELEON MOUNTING A - included (3pcs). Mounting screws are not included /
Zestaw zawiera 3 sztuki elementu CAMELEON MOUNTING A. Zestaw nie zawiera wkrętów montażowych /
CAMELEON MOUNTING A - включено (3 шт.). Монтажные винты не включены

CAMELEON MOUNTING A

plastic / tworzywo sztuczne / пластик
8395 ● BL 8396 ○ WH

application: wall / ceiling
zastosowanie: ściana / sufit
применение: стена / потолок

allows the change of wire direction
umożliwia zmianę kierunku przebiegu przewodu

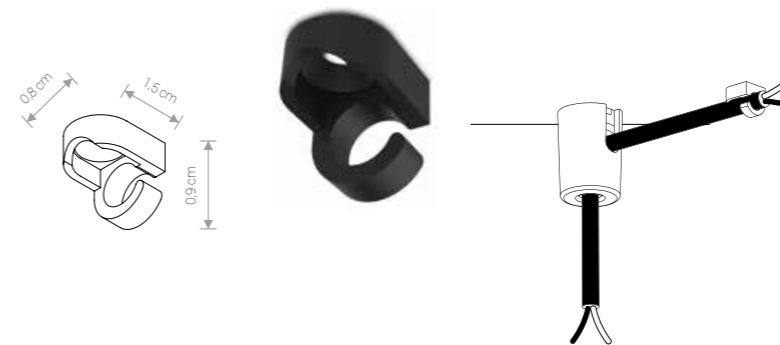

CAMELEON MOUNTING B

CAMELEON MOUNTING B included (5pcs). Mounting screws are included (5pcs) /
Zestaw zawiera 5 sztuk elementu CAMELEON MOUNTING B. Zestaw zawiera 5 wkrętów montażowych /
CAMELEON MOUNTING B - включено (5 шт.). Монтажные винты включены (5 шт.)

CAMELEON MOUNTING B

plastic / tworzywo sztuczne / пластик
8393 ● BL 8394 ○ WH

application: wall / ceiling
zastosowanie: ściana / sufit
применение: стена / потолок

prevents wire from sagging
zapobiega obwisaniu przewodu



CAMELEON MOUNTING C

CAMELEON MOUNTING C - included (5pcs). Mounting screws - not included /
Zestaw zawiera 5 sztuk elementu CAMELEON MOUNTING C. Zestaw nie zawiera wkrętów montażowych /
CAMELEON MOUNTING C - включено (5 шт.). Монтажные винты не включены





CAMELEON MOUNTING C

brass / mosiądz / латунь
8405 ● BS

application: wall / ceiling
zastosowanie: ściana / sufit
применение: стена / потолок

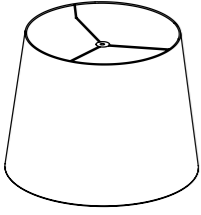
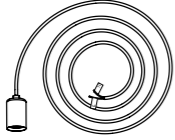
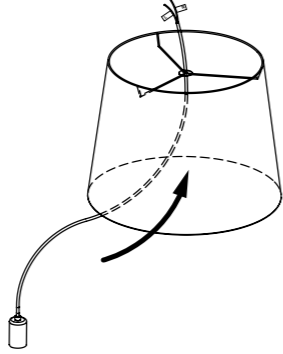
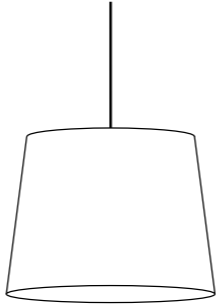
prevents wire from sagging
zapobiega obwisaniu przewodu

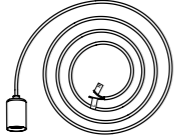
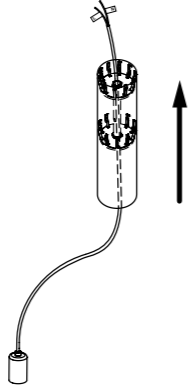
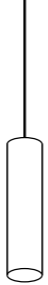
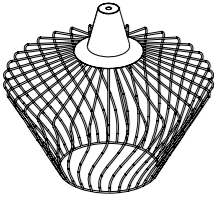
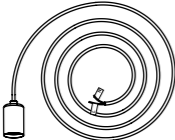
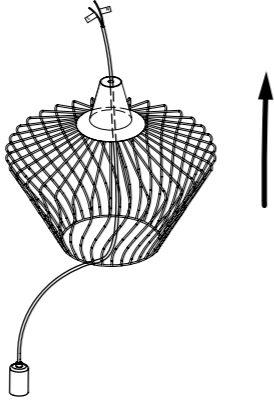
CAMELEON MANUALS

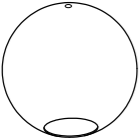
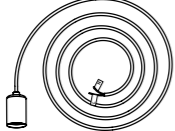
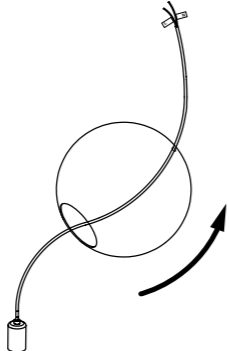
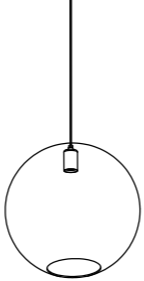
LAMP SHADE	SUSPENSION	SUSPENSION + LAMP SHADE	READY FOR INSTALLATION
KLOSZ АБАЖУРЫ	ZAWIESZENIE ПОДВЕС	ZAWIESZENIE + KLOSZ ПОДВЕС + АБАЖУРЫ	GOTOWE DO ZAMONTOWANIA ГОТОВ К МОНТАЖУ
			
			
			
			

CAMELEON POSSIBILITIES

CANOPY A

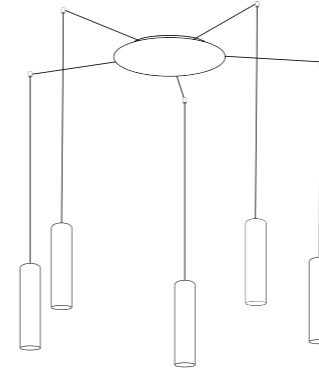

CANOPY B

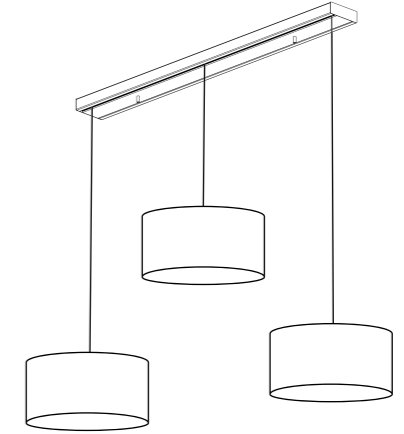

CANOPY C

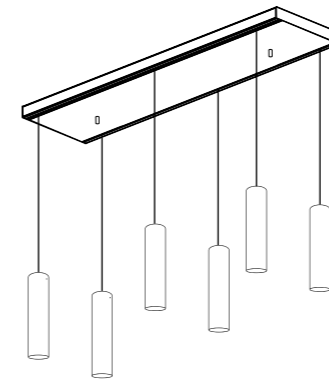

CANOPY D

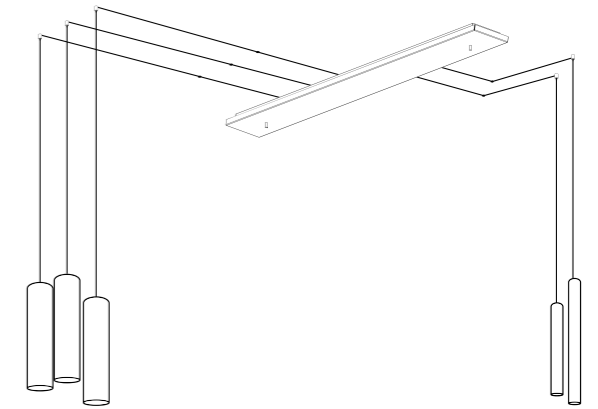

CANOPY E

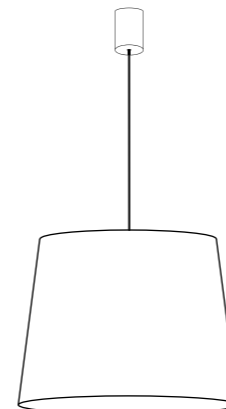

CANOPY F

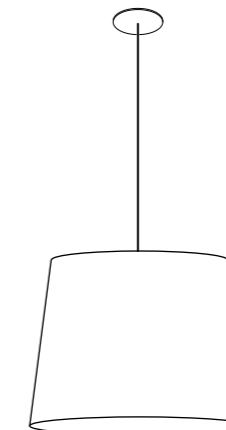

CANOPY G

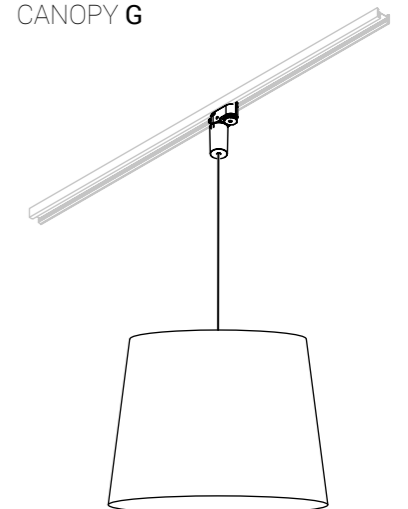

CANOPY A

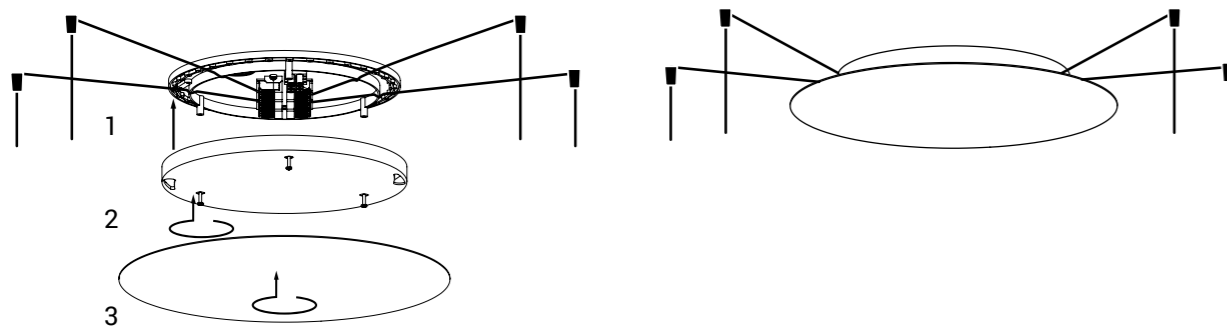
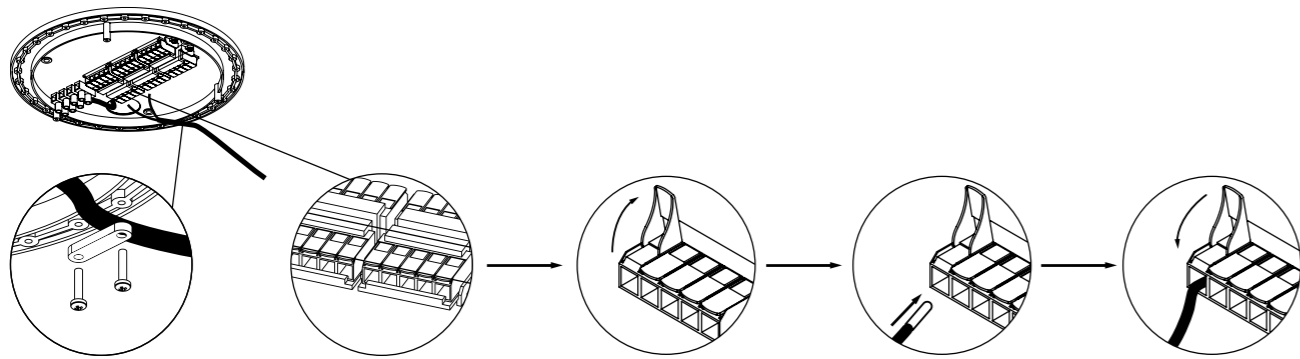
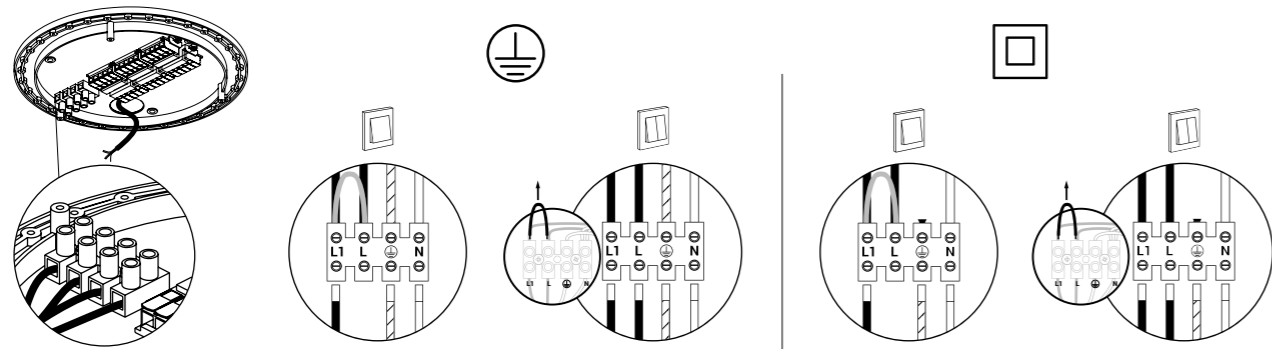
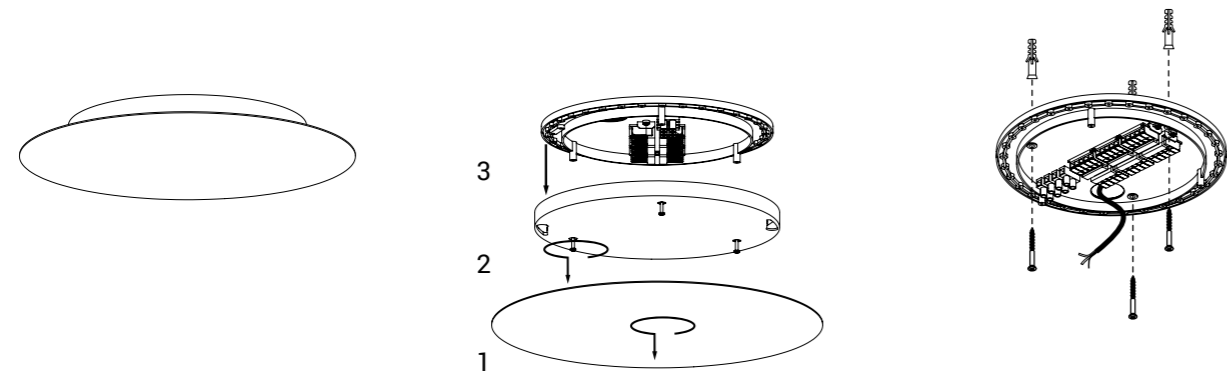

CANOPY B 780 B 1500

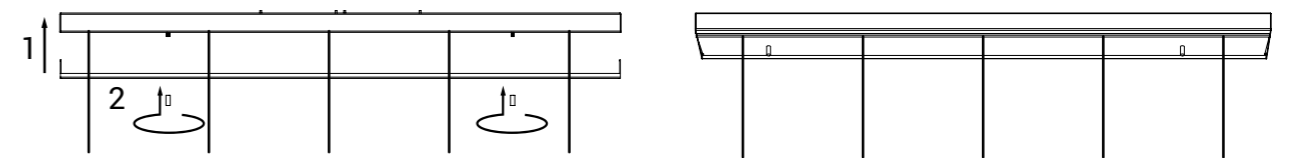
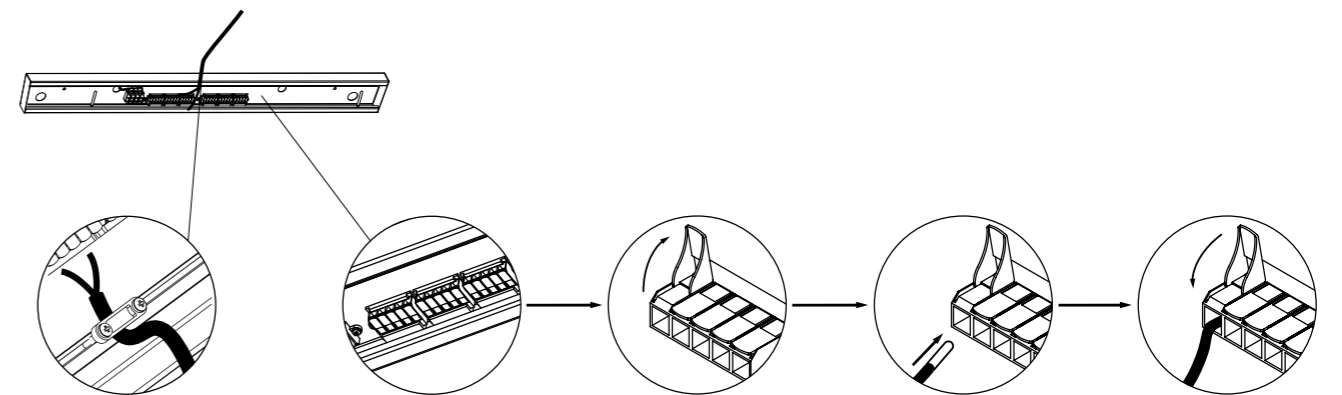
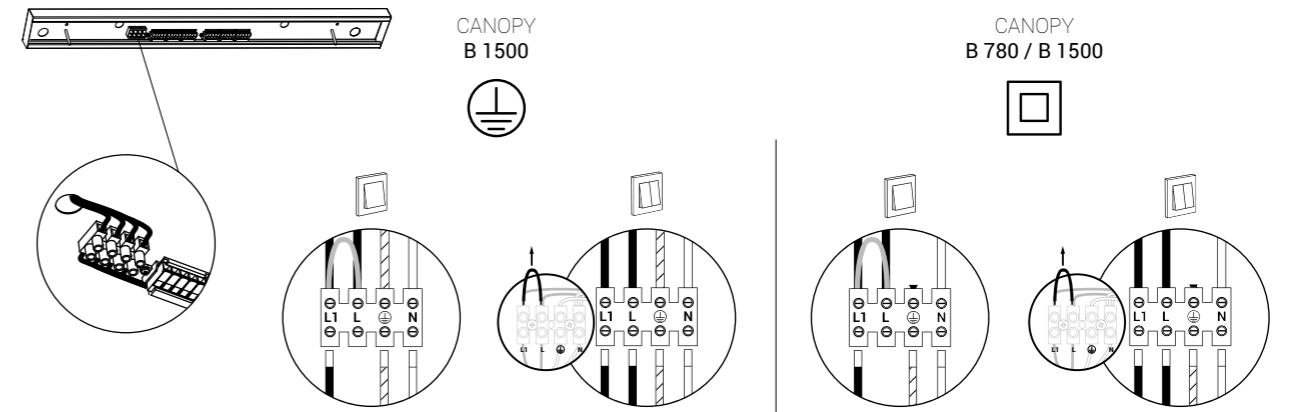
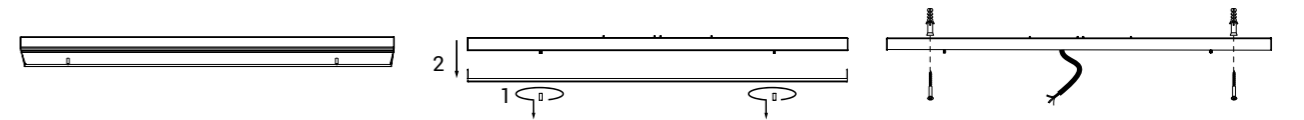

CANOPY C 780
C 1200

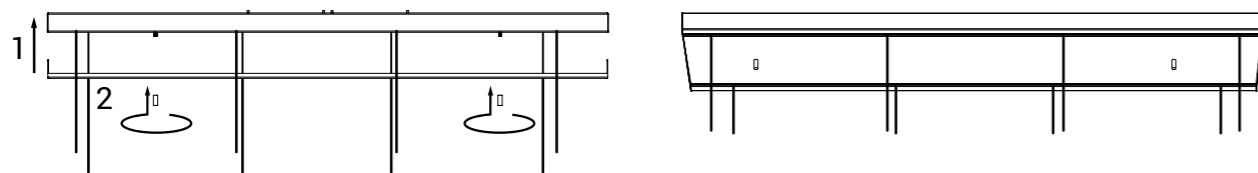
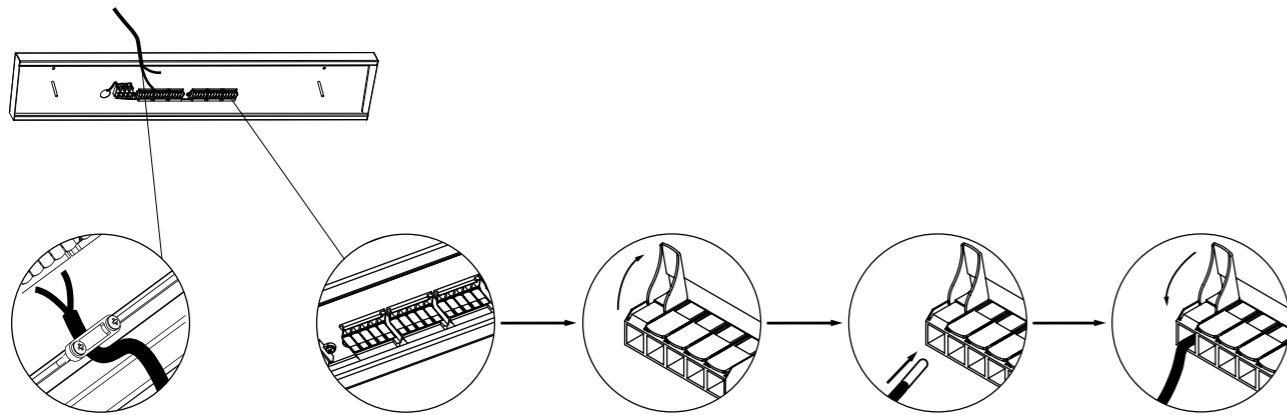
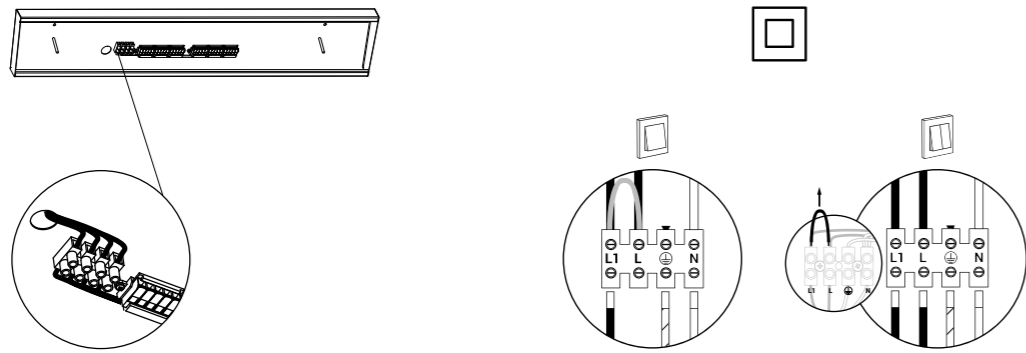
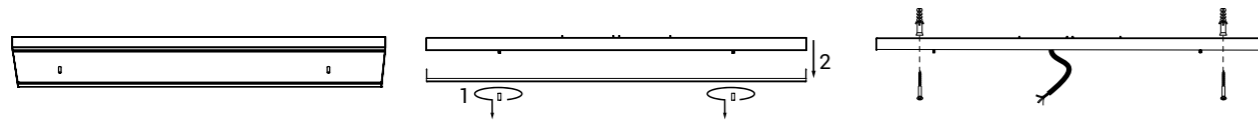

CANOPY D 780

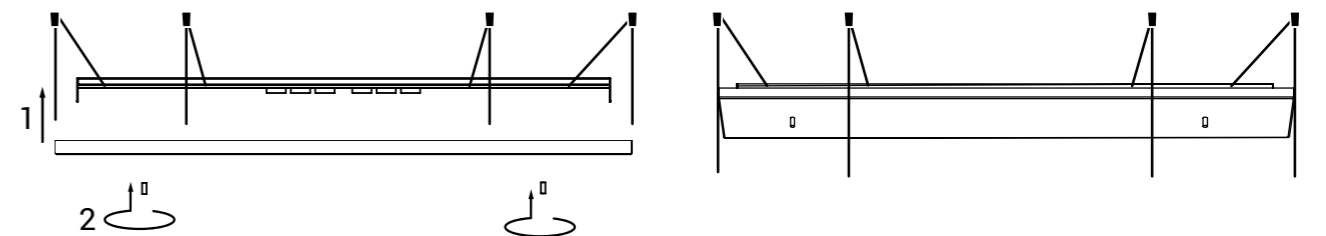
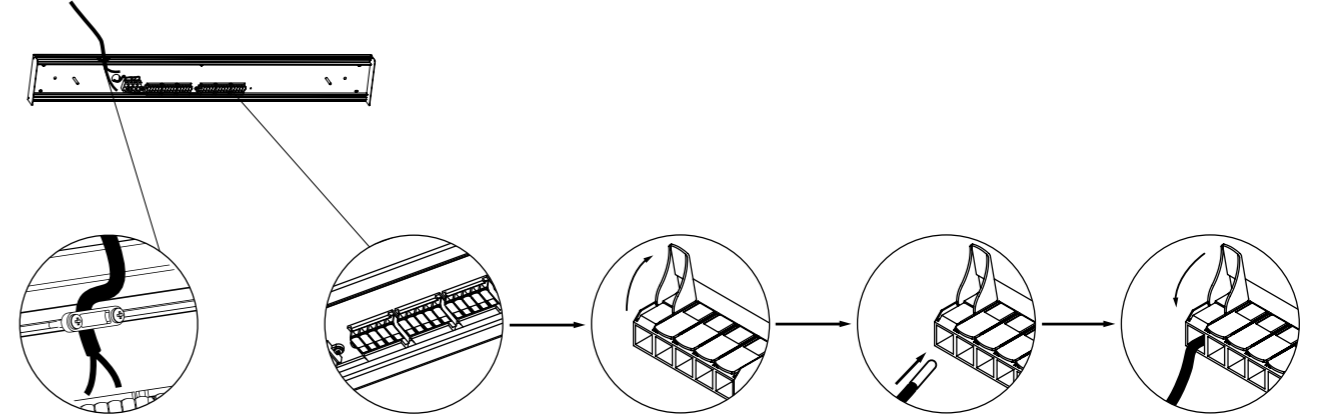
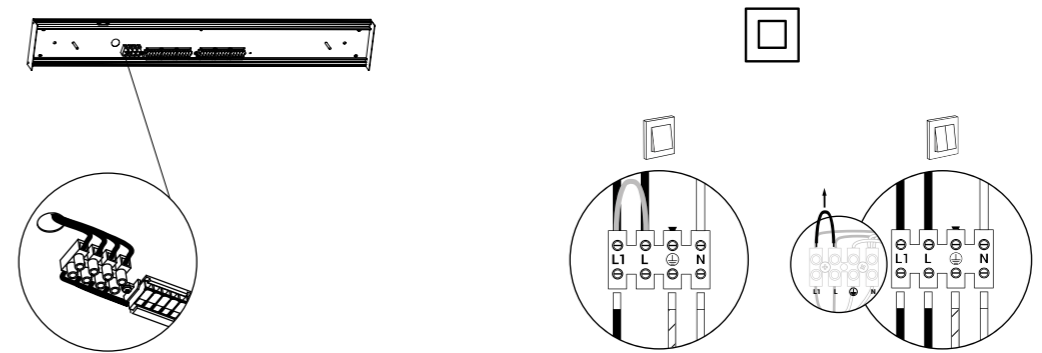
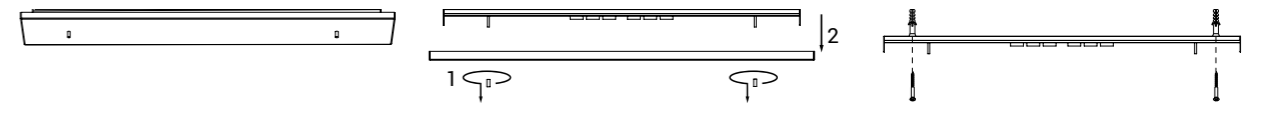

CANOPY E

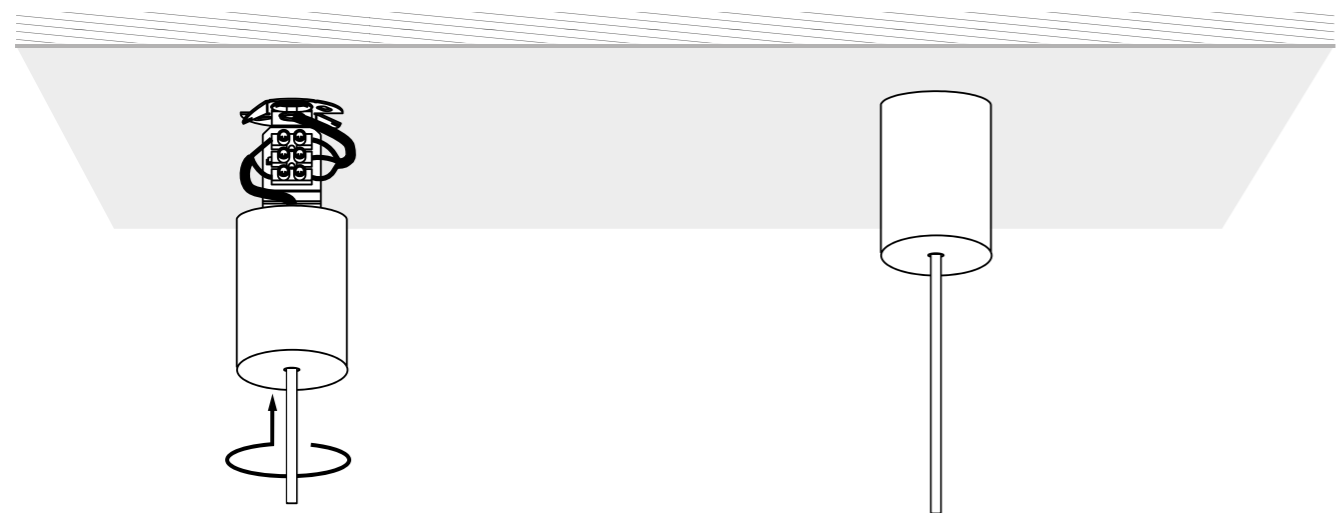
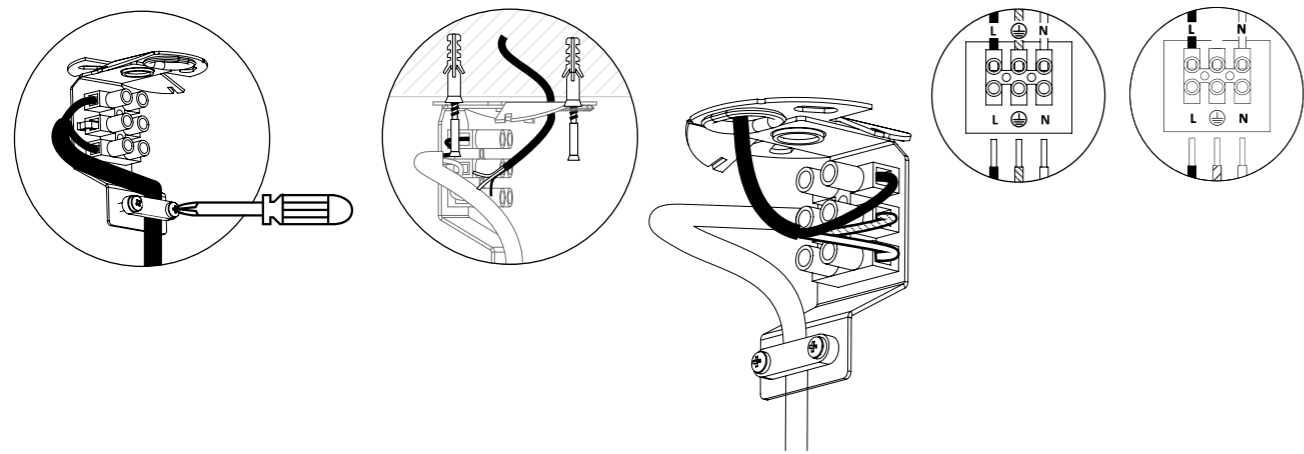
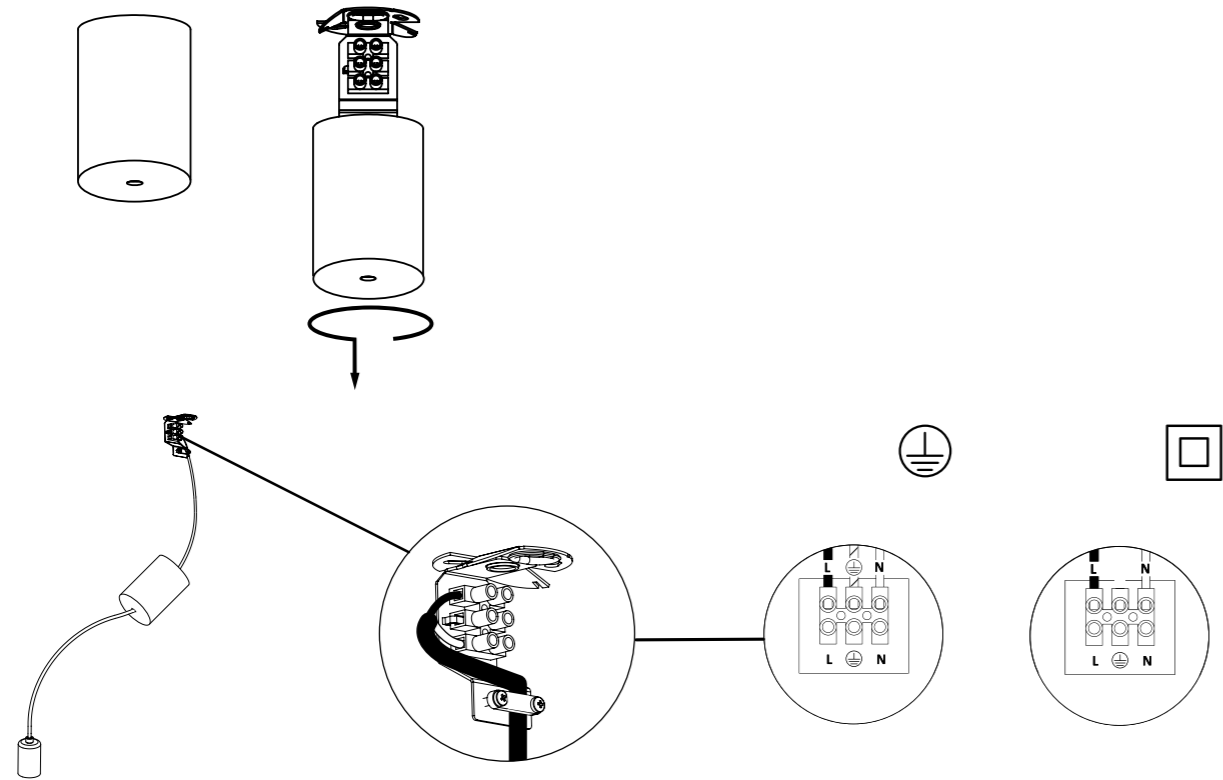

CANOPY F

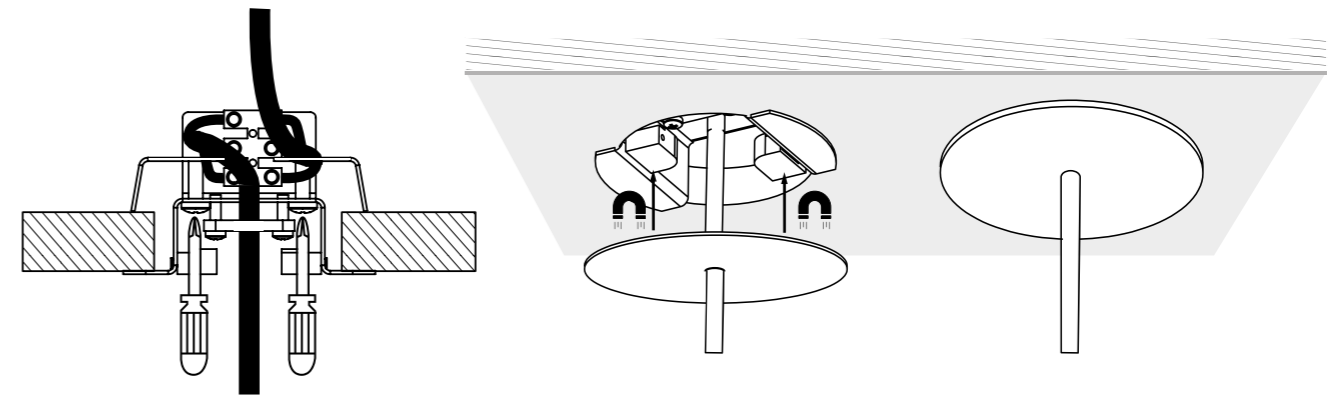
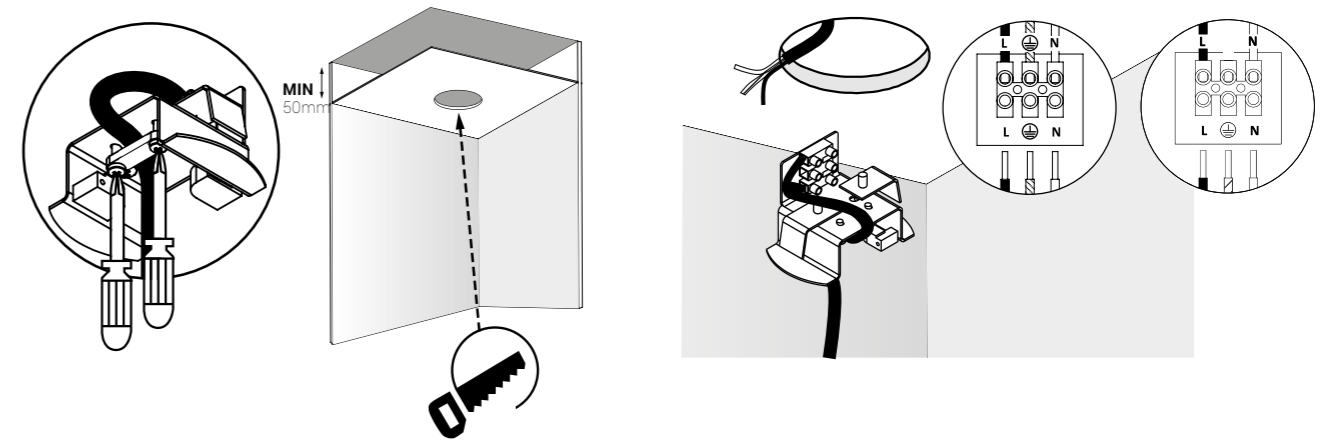
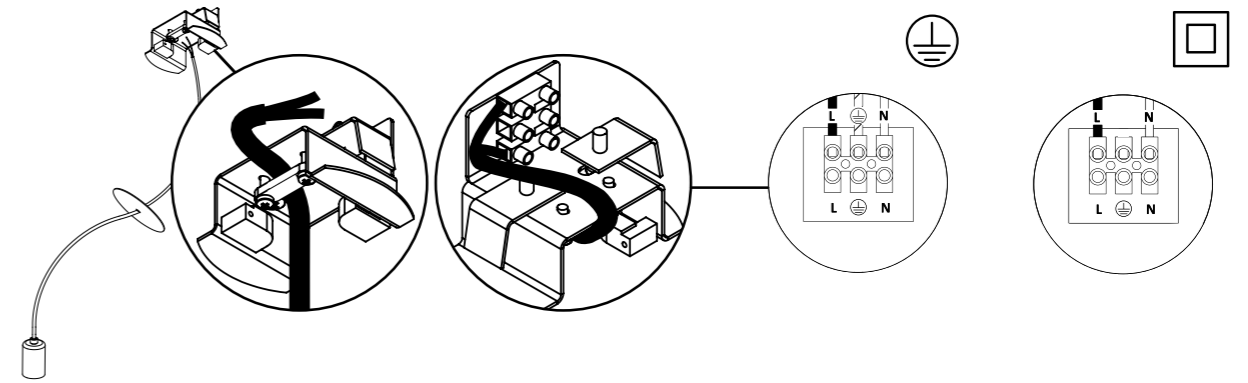
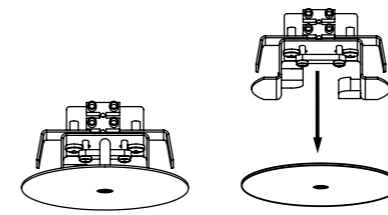

CANOPY G

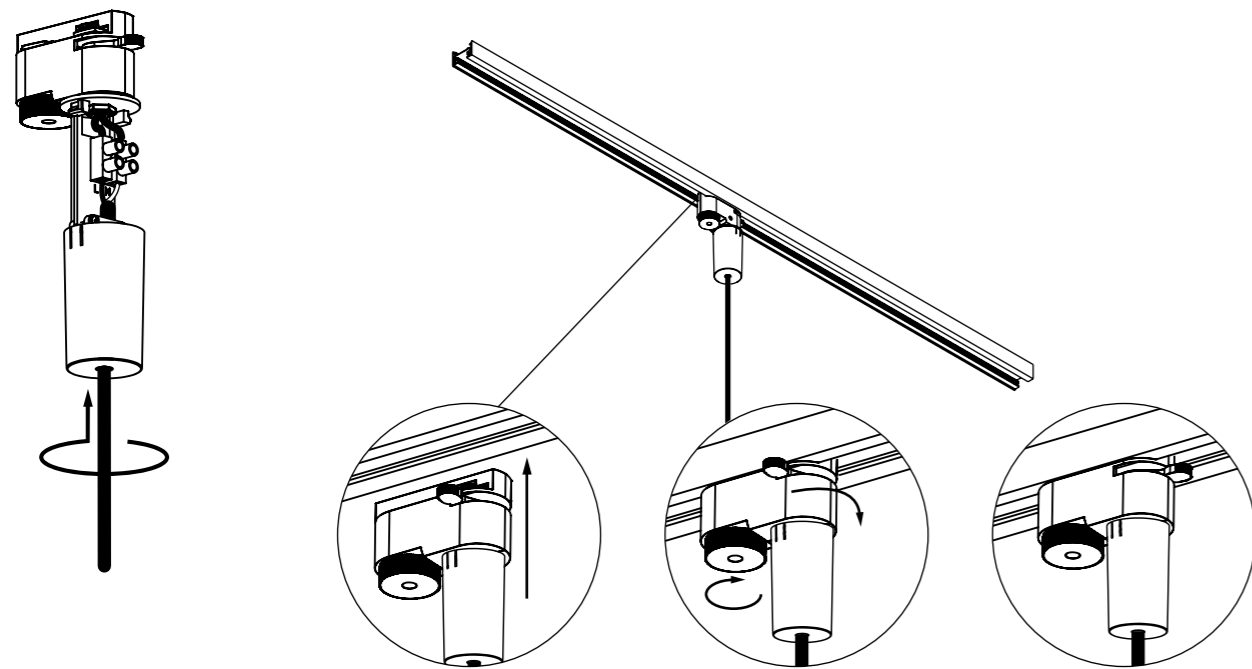
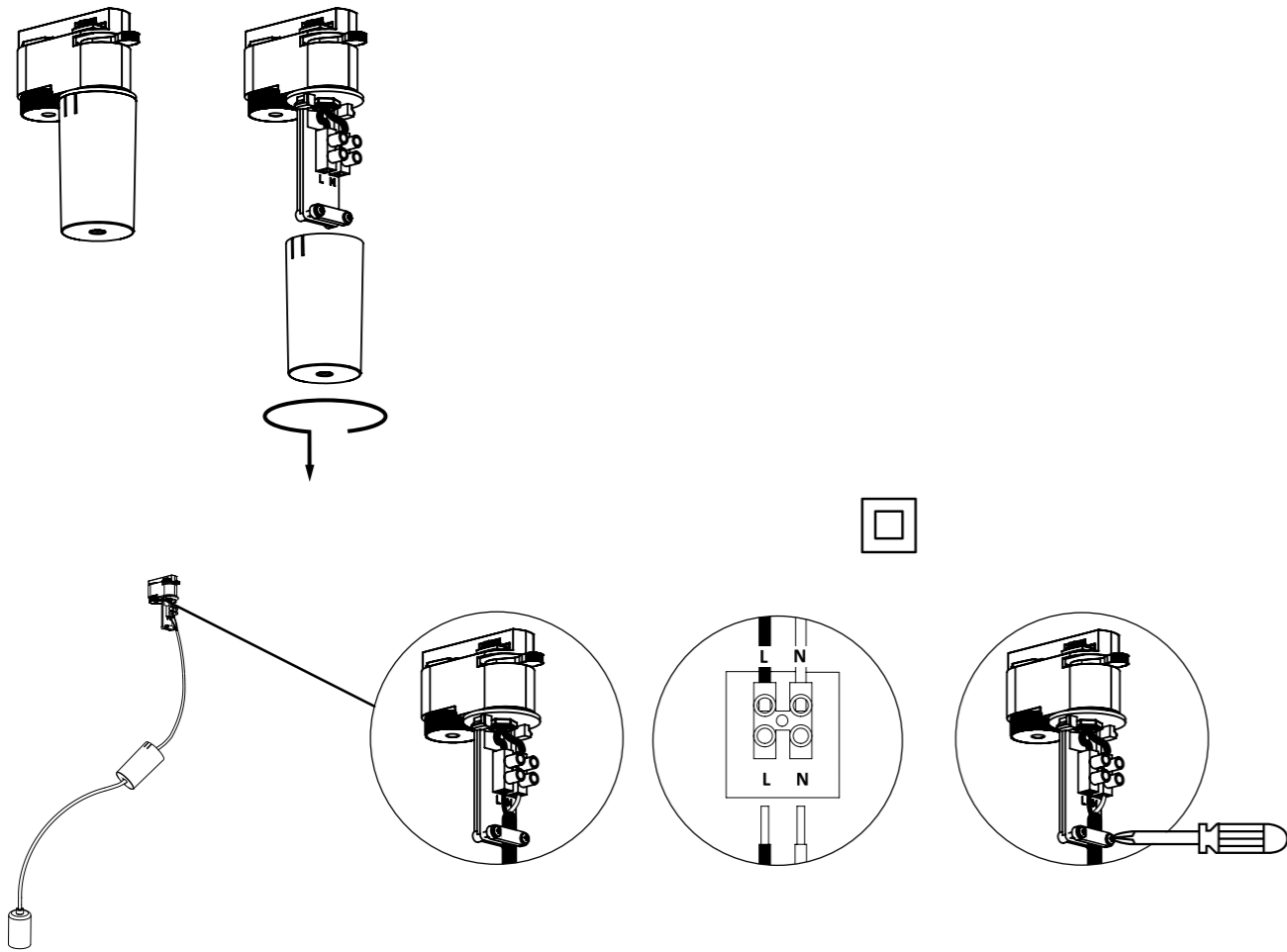

ZONES

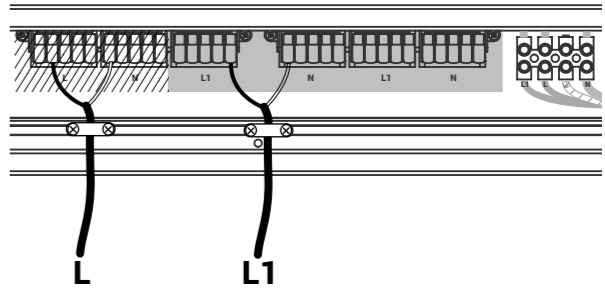
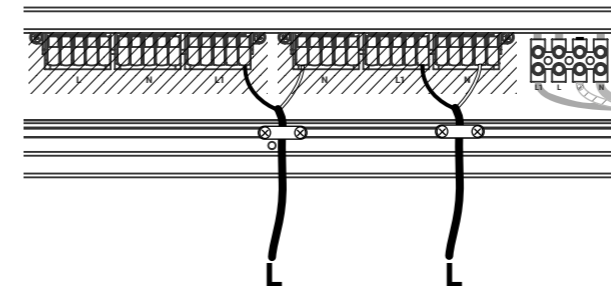
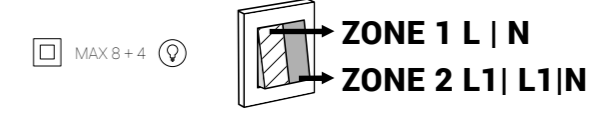
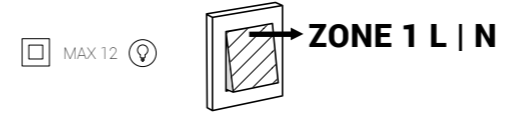
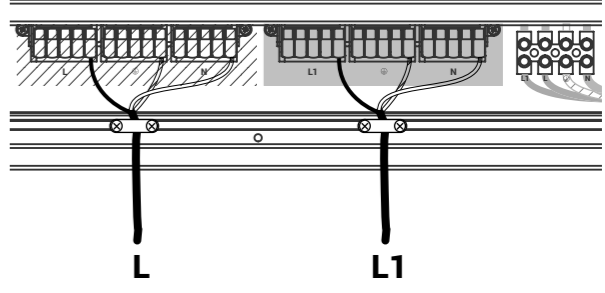
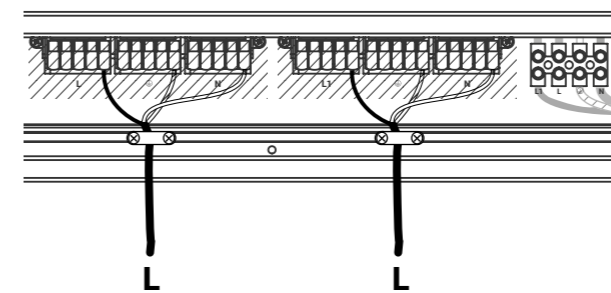
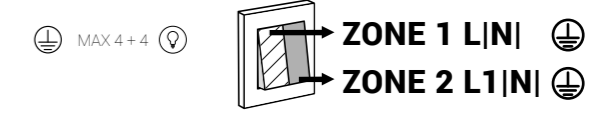
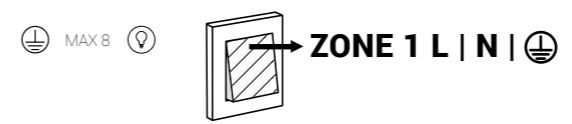
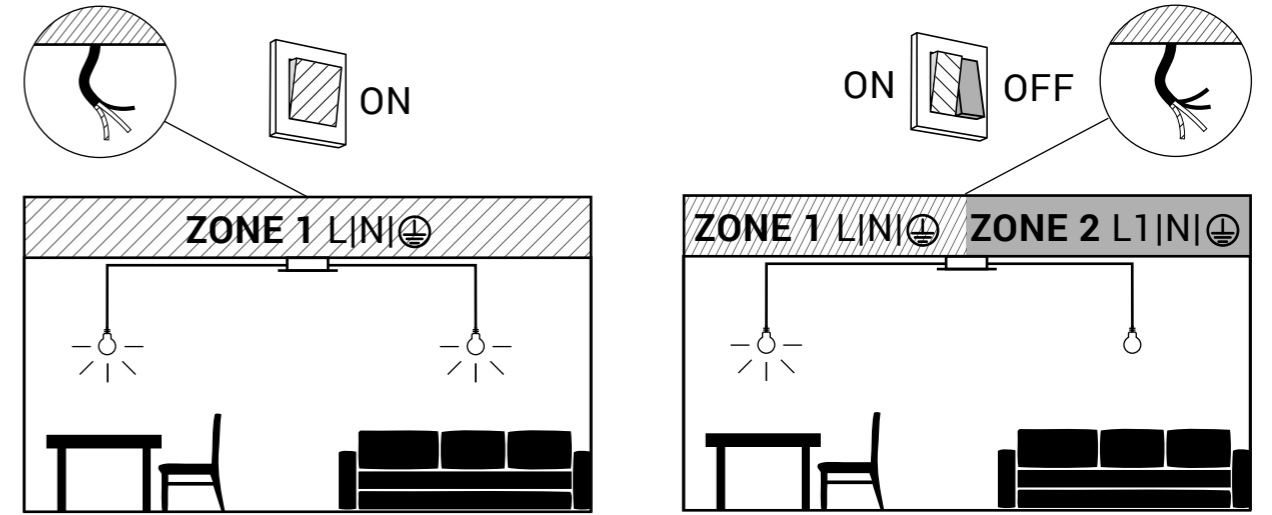

ALPHABETICAL INDEX / ALFABETYCZNY SPIS TREŚCI

A	G
ABI L 23	GEOMETRIC 35
ABI M 23	GSTAR 25
ABI S 23	
A LED 66	H
	H LED 63
B	L
BARREL L 60	LASER 500 28
BARREL THIN S 59	LASER 750 28
BARREL WIDE S 58	LASER 1000 28
BIO M 46	LUKSOR L 21
BIO S 46	LUKSOR S 21
C	M
CABLE E27 68	MOUNTING A 73
CABLE G9 68	MOUNTING B 73
CABLE GU10 68	MOUNTING C 73
CANOPY A 69	
CANOPY B 780, B 1500 70	P
CANOPY C 780, C 1200 71	PEAR L 43
CANOPY D 780 69	PEAR M 43
CANOPY E 72	PEAR S 43
CANOPY F 72	PICO 22
CANOPY G 72	POLY L 32
CONE L 53	POLY M 32
CONE M 52	
CONE S 54	Q
CYLINDER L 38	Q LED 67
CYLINDER M 38	
CYLINDER S 38	S
D	SPHERE L 44
DOVER 47	SPHERE M 44
	SPHERE S 44
E	SPHERE XL 44
EGG M 26	STRAW M 39
EYE L 30	STRAW S 39
EYE M 30	

T	W
TULUM 33	WAVE L 19
	WAVE S 19
U	WHEEL 48
UMBRELLA 25	

PROGRESSIVE CODE INDEX / INDEKS LAMP

INDEX	PAGE/STRONA	INDEX	PAGE/STRONA	INDEX	PAGE/STRONA	INDEX	PAGE/STRONA
8360	72	8451	66	8491	53	8524	59
8361	72	8452	67	8492	53	8525	59
8393	73	8453	67	8493	53	8526	59
8394	73	8454	63	8494	53	8527	44
8395	73	8455	63	8495	52	8528	44
8396	73	8457	46	8496	52	8530	44
8400	39	8458	46	8497	52	8531	44
8401	39	8461	46	8498	52	8532	43
8402	39	8462	46	8500	54	8533	43
8403	39	8463	47	8501	54	8534	43
8405	73	8464	47	8502	54	8535	39
8406	53	8465	35	8503	54	8536	39
8407	53	8466	35	8503	54	8537	38
8408	53	8467	33	8504	54	8538	38
8410	53	8471	32	8505	54	8540	38
8411	52	8472	32	8506	60	8541	38
8412	52	8473	32	8507	60	8542	38
8413	52	8474	32	8508	60	8543	38
8414	52	8475	31	8510	60	8544	38
8415	54	8476	31	8511	60	8545	38
8416	54	8477	31	8512	58	8546	38
8417	60	8478	31	8513	58	8547	72
8418	60	8480	31	8514	58	8548	72
8420	60	8481	31	8515	58	8550	72
8421	58	8482	31	8516	58	8551	72
8422	59	8483	31	8517	58	8552	69
8423	48	8484	30	8518	58	8553	69
8424	48	8485	30	8520	59	8554	71
8425	35	8486	28	8521	59	8556	71
8426	33	8487	28	8522	59	8557	71
8450	66	8488	28	8523	59	8558	70

INDEX	PAGE/STRONA	INDEX	PAGE/STRONA	INDEX	PAGE/STRONA	INDEX	PAGE/STRONA
8560	70	8587	23	8615	68	8643	68
8561	70	8588	22	8616	68	8644	68
8562	70	8590	22	8617	68	8645	68
8563	69	8591	22	8618	68	8646	68
8564	69	8592	21	8620	68	8647	68
8565	69	8593	21	8621	68	8648	68
8566	69	8594	68	8622	68	8650	68
8567	28	8595	68	8623	68	8651	68
8568	28	8596	21	8624	68	8652	68
8570	28	8597	21	8625	68	8653	68
8571	28	8598	68	8626	68	8654	68
8572	28	8600	19	8627	68	8655	68
8573	28	8601	68	8628	68	8656	68
8574	25	8602	19	8630	68	8657	68
8575	25	8603	19	8631	68	8658	68
8576	25	8604	19	8632	68	8660	68
8577	23	8605	19	8633	68	8661	68
8578	68	8606	19	8634	68	8662	68
8580	68	8607	26	8635	68	8663	68
8581	23	8608	70	8636	68	8664	68
8582	23	8610	70	8637	68	8665	68
8583	68	8611	68	8638	68	8666	68
8584	23	8612	68	8640	68	8667	68
8585	68	8613	68	8641	68	8668	68
8586	23	8614	68	8642	68	8670	68

NOTATKI

Lined area for notes, consisting of horizontal dashed lines.

COLOR CODES / KODY KOLORÓW

- WH - WHITE
- V WH - VELVET WHITE
- TR - TRANSPARENT
- TR/WH - TRANSPARENT/WHITE
- SI - SILVER
- GY - GRAY
- CN - CONCRETE
- GR - GRAPHITE
- BL - BLACK
- V BL - VELVET BLACK
- TR/BL - TRANSPARENT/BLACK
- BS - BRASS
- G - GOLD
- NT - NATURAL
- TR/G - TRANSPARENT/GOLD
- TR/BS - TRANSPARENT/BRASS
- WH/CH - WHITE/CHROME
- BL/CH - BLACK/CHROME
- BL/BS - BLACK/BRASS
- BL/G - BLACK/GOLD
- V NB/G - VELVET NAVI BLUE/GOLD
- V GN/G - VELVET GREEN/GOLD
- V PI/WH - VELVET PINK/ WHITE

Nowodvorski

L I G H T I N G

Nowodvorski sp.j.

 ul. Bojemskiego 11
42-202 Częstochowa
POLAND

 +48 34 344 91 10 / 11

 +48 34 344 91 12

 nowodvorski@nowodvorski.com

 www.nowodvorski.com



Design & production:

GRAFFITI
CREATIVE PEOPLE

REKLAMA & MEDIA
www.graffiti.com.pl